



**COMMONWEALTH OF PENNSYLVANIA
DEPARTMENT OF ENVIRONMENTAL PROTECTION
AIR QUALITY PROGRAM**

TITLE V/STATE OPERATING PERMIT

Issue Date: October 4, 2019

Effective Date: October 4, 2019

Expiration Date: October 4, 2024

In accordance with the provisions of the Air Pollution Control Act, the Act of January 8, 1960, P.L. 2119, as amended, and 25 Pa. Code Chapter 127, the Owner, [and Operator if noted] (hereinafter referred to as permittee) identified below is authorized by the Department of Environmental Protection (Department) to operate the air emission source(s) more fully described in this permit. This Facility is subject to all terms and conditions specified in this permit. Nothing in this permit relieves the permittee from its obligations to comply with all applicable Federal, State and Local laws and regulations.

The regulatory or statutory authority for each permit condition is set forth in brackets. All terms and conditions in this permit are federally enforceable applicable requirements unless otherwise designated as "State-Only" or "non-applicable" requirements.

TITLE V Permit No: 63-00015

Federal Tax Id - Plant Code: 34-1794583-2

Owner Information

Name: FLEXSYS AMER LP
Mailing Address: 829 ROUTE 481
MONONGAHELA, PA 15063-3437

Plant Information

Plant: FLEXSYS AMER LTD PAR/MONONGAHELA
Location: 63 Washington County 63919 Carroll Township
SIC Code: 2819 Manufacturing - Industrial Inorganic Chemicals, Nec

Responsible Official

Name: CLAY LEONARD
Title: PLANT MGR
Phone: (724) 310 - 2819

Permit Contact Person

Name: DANIEL GROW
Title: HSES MGR
Phone: (724) 310 - 2830

[Signature] _____

MARK R. GOROG, P.E., ENVIRONMENTAL PROGRAM MANAGER, SOUTHWEST REGION



SECTION A. Table of Contents

Section A. Facility/Source Identification

Table of Contents
Site Inventory List

Section B. General Title V Requirements

- #001 Definitions
- #002 Prohibition of Air Pollution
- #003 Property Rights
- #004 Permit Expiration
- #005 Permit Renewal
- #006 Transfer of Ownership or Operational Control
- #007 Inspection and Entry
- #008 Compliance Requirements
- #009 Need to Halt or Reduce Activity Not a Defense
- #010 Duty to Provide Information
- #011 Reopening and Revising the Title V Permit for Cause
- #012 Reopening a Title V Permit for Cause by EPA
- #013 Operating Permit Application Review by the EPA
- #014 Significant Operating Permit Modifications
- #015 Minor Operating Permit Modifications
- #016 Administrative Operating Permit Amendments
- #017 Severability Clause
- #018 Fee Payment
- #019 Authorization for De Minimis Emission Increases
- #020 Reactivation of Sources
- #021 Circumvention
- #022 Submissions
- #023 Sampling, Testing and Monitoring Procedures
- #024 Recordkeeping Requirements
- #025 Reporting Requirements
- #026 Compliance Certification
- #027 Operational Flexibility
- #028 Risk Management
- #029 Approved Economic Incentives and Emission Trading Programs
- #030 Permit Shield

Section C. Site Level Title V Requirements

- C-I: Restrictions
- C-II: Testing Requirements
- C-III: Monitoring Requirements
- C-IV: Recordkeeping Requirements
- C-V: Reporting Requirements
- C-VI: Work Practice Standards
- C-VII: Additional Requirements
- C-VIII: Compliance Certification
- C-IX: Compliance Schedule

Section D. Source Level Title V Requirements

- D-I: Restrictions
- D-II: Testing Requirements
- D-III: Monitoring Requirements
- D-IV: Recordkeeping Requirements
- D-V: Reporting Requirements
- D-VI: Work Practice Standards
- D-VII: Additional Requirements



SECTION A. Table of Contents

Note: These same sub-sections are repeated for each source!

Section E. Source Group Restrictions

- E-I: Restrictions
- E-II: Testing Requirements
- E-III: Monitoring Requirements
- E-IV: Recordkeeping Requirements
- E-V: Reporting Requirements
- E-VI: Work Practice Standards
- E-VII: Additional Requirements

Section F. Alternative Operating Scenario(s)

- F-I: Restrictions
- F-II: Testing Requirements
- F-III: Monitoring Requirements
- F-IV: Recordkeeping Requirements
- F-V: Reporting Requirements
- F-VI: Work Practice Standards
- F-VII: Additional Requirements

Section G. Emission Restriction Summary

Section H. Miscellaneous

**SECTION A. Site Inventory List**

Source ID	Source Name	Capacity/Throughput		Fuel/Material
034	BOILER #1	25.100	MMBTU/HR	
		24.100	MCF/HR	Natural Gas
		178.000	Gal/HR	#2 Oil
035	BOILER #2	25.100	MMBTU/HR	
		24.100	MCF/HR	Natural Gas
		178.000	Gal/HR	#2 Oil
103	VAPORIZER	12.500	MMBTU/HR	
		88.700	Gal/HR	#2 Oil
		12.000	MCF/HR	Natural Gas
101	CRYSTEX PLANT	3.100	Tons/HR	INSOLUBLE SULFUR
115	SULFUR RAILCAR UNLOADING	50.000	Tons/HR	SULFUR RAILCARS
117	SULFUR STORAGE TANKS	1,200.000	Gal/HR	SULFUR
123	PROCESS OIL TANK #1	3,000.000	Gal/HR	PROCESS OIL
124	PROCESS OIL TANK #2	3,000.000	Gal/HR	PROCESS OIL
125	TANK TRUCK UNLOADING OF SULFUR	22.000	Tons/HR	
201	EMERGENCY DIESEL GENERATOR (226 BHP)	12.000	Gal/HR	Diesel Fuel
202	EMERGENCY FIRE PUMP ENGINE #1 (152 BHP)	1.110	MMBTU/HR	
		8.000	Gal/HR	Diesel Fuel
203	EMERGENCY FIRE PUMP ENGINE #2 (238 BHP)	1.680	MMBTU/HR	
		12.000	Gal/HR	Diesel Fuel
C01	CS2 RECOVERY ABSORBER			
C02	THERMAL OXIDIZER			
C04A	DONALDSON TORIT PACKAGING BAGHOUSE			
C101	CRYSTEX PLANT EMERGENCY FLARE			
C115	SULFUR RAILCAR UNLOADING ADSORBER			
S02	THERMAL OXIDIZER STACK			
S034	BOILER #1 STACK			
S035	BOILER #2 STACK			
S04A	CRYSTEX PACKAGING REPLACEMENT BAGHOUSE STACK			
S05	VAPORIZER STACK			
S06	CS2 RECOVERY ABSORBER STACK (BYPASS)			
S101	CRYSTEX PLANT EMERGENCY FLARE STACK			
S115	SULFUR RAILCAR UNLOADING ADSORBER STACK			
S201	EMERGENCY DIESEL GENERATOR (226 BHP) STACK			
S202	EMERGENCY FIRE PUMP ENGINE #1 STACK			
S203	EMERGENCY FIRE PUMP ENGINES STACKS (2)			
Z117	FUGITIVE EMISSIONS FROM SULFUR TANKS 117			
Z123	PROCESS OIL TANK #1 EXHAUST			
Z124	PROCESS OIL TANK #2 EXHAUST			
Z125	TANK TRUCK UNLOADING OF SULFUR FUGITIVES			



PERMIT MAPS

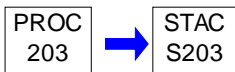
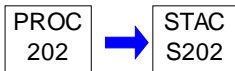
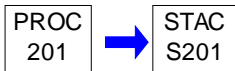
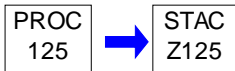
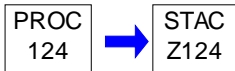
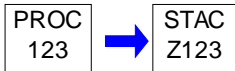
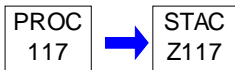
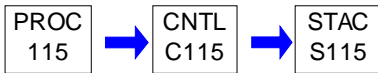
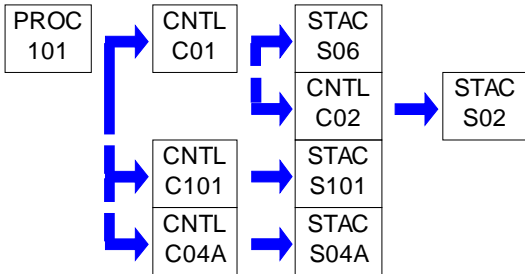
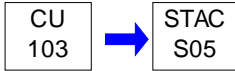
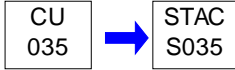
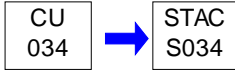

**SECTION B. General Title V Requirements****#001 [25 Pa. Code § 121.1]****Definitions**

Words and terms that are not otherwise defined in this permit shall have the meanings set forth in Section 3 of the Air Pollution Control Act (35 P.S. § 4003) and 25 Pa. Code § 121.1.

#002 [25 Pa. Code § 121.7]**Prohibition of Air Pollution**

No person may permit air pollution as that term is defined in the act.

#003 [25 Pa. Code § 127.512(c)(4)]**Property Rights**

This permit does not convey property rights of any sort, or any exclusive privileges.

#004 [25 Pa. Code § 127.446(a) and (c)]**Permit Expiration**

This operating permit is issued for a fixed term of five (5) years and shall expire on the date specified on Page 1 of this permit. The terms and conditions of the expired permit shall automatically continue pending issuance of a new Title V permit, provided the permittee has submitted a timely and complete application and paid applicable fees required under 25 Pa. Code Chapter 127, Subchapter I and the Department is unable, through no fault of the permittee, to issue or deny a new permit before the expiration of the previous permit. An application is complete if it contains sufficient information to begin processing the application, has the applicable sections completed and has been signed by a responsible official.

#005 [25 Pa. Code §§ 127.412, 127.413, 127.414, 127.446(e) & 127.503]**Permit Renewal**

(a) An application for the renewal of the Title V permit shall be submitted to the Department at least six (6) months, and not more than 18 months, before the expiration date of this permit. The renewal application is timely if a complete application is submitted to the Department's Regional Air Manager within the timeframe specified in this permit condition.

(b) The application for permit renewal shall include the current permit number, the appropriate permit renewal fee, a description of any permit revisions and off-permit changes that occurred during the permit term, and any applicable requirements that were promulgated and not incorporated into the permit during the permit term.

(c) The renewal application shall also include submission of proof that the local municipality and county, in which the facility is located, have been notified in accordance with 25 Pa. Code § 127.413. The application for renewal of the Title V permit shall also include submission of compliance review forms which have been used by the permittee to update information submitted in accordance with either 25 Pa. Code § 127.412(b) or § 127.412(j).

(d) The permittee, upon becoming aware that any relevant facts were omitted or incorrect information was submitted in the permit application, shall promptly submit such supplementary facts or corrected information during the permit renewal process. The permittee shall also promptly provide additional information as necessary to address any requirements that become applicable to the source after the date a complete renewal application was submitted but prior to release of a draft permit.

#006 [25 Pa. Code §§ 127.450(a)(4) & 127.464(a)]**Transfer of Ownership or Operational Control**

(a) In accordance with 25 Pa. Code § 127.450(a)(4), a change in ownership or operational control of the source shall be treated as an administrative amendment if:

- (1) The Department determines that no other change in the permit is necessary;
- (2) A written agreement has been submitted to the Department identifying the specific date of the transfer of permit responsibility, coverage and liability between the current and the new permittee; and,
- (3) A compliance review form has been submitted to the Department and the permit transfer has been approved by the Department.

**SECTION B. General Title V Requirements**

(b) In accordance with 25 Pa. Code § 127.464(a), this permit may not be transferred to another person except in cases of transfer-of-ownership which are documented and approved to the satisfaction of the Department.

#007 [25 Pa. Code § 127.513, 35 P.S. § 4008 and § 114 of the CAA]**Inspection and Entry**

(a) Upon presentation of credentials and other documents as may be required by law for inspection and entry purposes, the permittee shall allow the Department of Environmental Protection or authorized representatives of the Department to perform the following:

- (1) Enter at reasonable times upon the permittee's premises where a Title V source is located or emissions related activity is conducted, or where records are kept under the conditions of this permit;
- (2) Have access to and copy or remove, at reasonable times, records that are kept under the conditions of this permit;
- (3) Inspect at reasonable times, facilities, equipment including monitoring and air pollution control equipment, practices, or operations regulated or required under this permit;
- (4) Sample or monitor, at reasonable times, substances or parameters, for the purpose of assuring compliance with the permit or applicable requirements as authorized by the Clean Air Act, the Air Pollution Control Act, or the regulations promulgated under the Acts.

(b) Pursuant to 35 P.S. § 4008, no person shall hinder, obstruct, prevent or interfere with the Department or its personnel in the performance of any duty authorized under the Air Pollution Control Act.

(c) Nothing in this permit condition shall limit the ability of the EPA to inspect or enter the premises of the permittee in accordance with Section 114 or other applicable provisions of the Clean Air Act.

#008 [25 Pa. Code §§ 127.25, 127.444, & 127.512(c)(1)]**Compliance Requirements**

(a) The permittee shall comply with the conditions of this permit. Noncompliance with this permit constitutes a violation of the Clean Air Act and the Air Pollution Control Act and is grounds for one (1) or more of the following:

- (1) Enforcement action
- (2) Permit termination, revocation and reissuance or modification
- (3) Denial of a permit renewal application

(b) A person may not cause or permit the operation of a source, which is subject to 25 Pa. Code Article III, unless the source(s) and air cleaning devices identified in the application for the plan approval and operating permit and the plan approval issued to the source are operated and maintained in accordance with specifications in the applications and the conditions in the plan approval and operating permit issued by the Department. A person may not cause or permit the operation of an air contamination source subject to 25 Pa. Code Chapter 127 in a manner inconsistent with good operating practices.

(c) For purposes of Sub-condition (b) of this permit condition, the specifications in applications for plan approvals and operating permits are the physical configurations and engineering design details which the Department determines are essential for the permittee's compliance with the applicable requirements in this Title V permit.

#009 [25 Pa. Code § 127.512(c)(2)]**Need to Halt or Reduce Activity Not a Defense**

It shall not be a defense for a permittee in an enforcement action that it would have been necessary to halt or reduce the permitted activity in order to maintain compliance with the conditions of this permit.

#010 [25 Pa. Code §§ 127.411(d) & 127.512(c)(5)]**Duty to Provide Information**

(a) The permittee shall furnish to the Department, within a reasonable time, information that the Department may request in writing to determine whether cause exists for modifying, revoking and reissuing, or terminating the permit, or

**SECTION B. General Title V Requirements**

to determine compliance with the permit.

(b) Upon request, the permittee shall also furnish to the Department copies of records that the permittee is required to keep by this permit, or for information claimed to be confidential, the permittee may furnish such records directly to the Administrator of EPA along with a claim of confidentiality.

#011 [25 Pa. Code §§ 127.463, 127.512(c)(3) & 127.542]**Reopening and Revising the Title V Permit for Cause**

(a) This Title V permit may be modified, revoked, reopened and reissued or terminated for cause. The filing of a request by the permittee for a permit modification, revocation and reissuance, or termination, or of a notification of planned changes or anticipated noncompliance does not stay a permit condition.

(b) This permit may be reopened, revised and reissued prior to expiration of the permit under one or more of the following circumstances:

(1) Additional applicable requirements under the Clean Air Act or the Air Pollution Control Act become applicable to a Title V facility with a remaining permit term of three (3) or more years prior to the expiration date of this permit. The Department will revise the permit as expeditiously as practicable but not later than 18 months after promulgation of the applicable standards or regulations. No such revision is required if the effective date of the requirement is later than the expiration date of this permit, unless the original permit or its terms and conditions has been extended.

(2) Additional requirements, including excess emissions requirements, become applicable to an affected source under the acid rain program. Upon approval by the Administrator of EPA, excess emissions offset plans for an affected source shall be incorporated into the permit.

(3) The Department or the EPA determines that this permit contains a material mistake or inaccurate statements were made in establishing the emissions standards or other terms or conditions of this permit.

(4) The Department or the Administrator of EPA determines that the permit must be revised or revoked to assure compliance with the applicable requirements.

(c) Proceedings to revise this permit shall follow the same procedures which apply to initial permit issuance and shall affect only those parts of this permit for which cause to revise exists. The revision shall be made as expeditiously as practicable.

(d) Regardless of whether a revision is made in accordance with (b)(1) above, the permittee shall meet the applicable standards or regulations promulgated under the Clean Air Act within the time frame required by standards or regulations.

#012 [25 Pa. Code § 127.543]**Reopening a Title V Permit for Cause by EPA**

As required by the Clean Air Act and regulations adopted thereunder, this permit may be modified, reopened and reissued, revoked or terminated for cause by EPA in accordance with procedures specified in 25 Pa. Code § 127.543.

#013 [25 Pa. Code § 127.522(a)]**Operating Permit Application Review by the EPA**

The applicant may be required by the Department to provide a copy of the permit application, including the compliance plan, directly to the Administrator of the EPA. Copies of title V permit applications to EPA, pursuant to 25 PA Code §127.522(a), shall be submitted, if required, to the following EPA e-mail box:

R3_Air_Apps_and_Notices@epa.gov

Please place the following in the subject line: TV [permit number], [Facility Name].

#014 [25 Pa. Code § 127.541]**Significant Operating Permit Modifications**

When permit modifications during the term of this permit do not qualify as minor permit modifications or administrative amendments, the permittee shall submit an application for significant Title V permit modifications in accordance with

**SECTION B. General Title V Requirements**

25 Pa. Code § 127.541. Notifications to EPA, pursuant to 25 PA Code §127.522(a), if required, shall be submitted, to the following EPA e-mail box:

R3_Air_Apps_and_Notices@epa.gov

Please place the following in the subject line: TV [permit number], [Facility Name].

#015 [25 Pa. Code §§ 121.1 & 127.462]**Minor Operating Permit Modifications**

The permittee may make minor operating permit modifications (as defined in 25 Pa. Code §121.1), on an expedited basis, in accordance with 25 Pa. Code §127.462 (relating to minor operating permit modifications). Notifications to EPA, pursuant to 25 PA Code §127.462(c), if required, shall be submitted, to the following EPA e-mail box:

R3_Air_Apps_and_Notices@epa.gov

Please place the following in the subject line: TV [permit number], [Facility Name].

#016 [25 Pa. Code § 127.450]**Administrative Operating Permit Amendments**

(a) The permittee may request administrative operating permit amendments, as defined in 25 Pa. Code §127.450(a). Copies of request for administrative permit amendment to EPA, pursuant to 25 PA Code §127.450(c)(1), if required, shall be submitted to the following EPA e-mail box:

R3_Air_Apps_and_Notices@epa.gov

Please place the following in the subject line: TV [permit number], [Facility Name].

(b) Upon final action by the Department granting a request for an administrative operating permit amendment covered under §127.450(a)(5), the permit shield provisions in 25 Pa. Code § 127.516 (relating to permit shield) shall apply to administrative permit amendments incorporated in this Title V Permit in accordance with §127.450(c), unless precluded by the Clean Air Act or the regulations thereunder.

#017 [25 Pa. Code § 127.512(b)]**Severability Clause**

The provisions of this permit are severable, and if any provision of this permit is determined by the Environmental Hearing Board or a court of competent jurisdiction, or US EPA to be invalid or unenforceable, such a determination will not affect the remaining provisions of this permit.

#018 [25 Pa. Code §§ 127.704, 127.705 & 127.707]**Fee Payment**

(a) The permittee shall pay fees to the Department in accordance with the applicable fee schedules in 25 Pa. Code Chapter 127, Subchapter I (relating to plan approval and operating permit fees).

(b) Emission Fees. The permittee shall, on or before September 1st of each year, pay applicable annual Title V emission fees for emissions occurring in the previous calendar year as specified in 25 Pa. Code § 127.705. The permittee is not required to pay an emission fee for emissions of more than 4,000 tons of each regulated pollutant emitted from the facility.

(c) As used in this permit condition, the term "regulated pollutant" is defined as a VOC, each pollutant regulated under Sections 111 and 112 of the Clean Air Act and each pollutant for which a National Ambient Air Quality Standard has been promulgated, except that carbon monoxide is excluded.

(d) Late Payment. Late payment of emission fees will subject the permittee to the penalties prescribed in 25 Pa. Code § 127.707 and may result in the suspension or termination of the Title V permit. The permittee shall pay a penalty of fifty percent (50%) of the fee amount, plus interest on the fee amount computed in accordance with 26 U.S.C.A. § 6621(a)(2) from the date the emission fee should have been paid in accordance with the time frame specified in 25 Pa. Code § 127.705(c).

**SECTION B. General Title V Requirements**

(e) The permittee shall pay an annual operating permit administration fee according to the fee schedule established in 25 Pa. Code § 127.704(c) if the facility, identified in Subparagraph (iv) of the definition of the term "Title V facility" in 25 Pa. Code § 121.1, is subject to Title V after the EPA Administrator completes a rulemaking requiring regulation of those sources under Title V of the Clean Air Act.

(f) This permit condition does not apply to a Title V facility which qualifies for exemption from emission fees under 35 P.S. § 4006.3(f).

#019 [25 Pa. Code §§ 127.14(b) & 127.449]**Authorization for De Minimis Emission Increases**

(a) This permit authorizes de minimis emission increases from a new or existing source in accordance with 25 Pa. Code §§ 127.14 and 127.449 without the need for a plan approval or prior issuance of a permit modification. The permittee shall provide the Department with seven (7) days prior written notice before commencing any de minimis emissions increase that would result from either: (1) a physical change of minor significance under § 127.14(c)(1); or (2) the construction, installation, modification or reactivation of an air contamination source. The written notice shall:

(1) Identify and describe the pollutants that will be emitted as a result of the de minimis emissions increase.

(2) Provide emission rates expressed in tons per year and in terms necessary to establish compliance consistent with any applicable requirement.

The Department may disapprove or condition de minimis emission increases at any time.

(b) Except as provided below in (c) and (d) of this permit condition, the permittee is authorized during the term of this permit to make de minimis emission increases (expressed in tons per year) up to the following amounts without the need for a plan approval or prior issuance of a permit modification:

(1) Four tons of carbon monoxide from a single source during the term of the permit and 20 tons of carbon monoxide at the facility during the term of the permit.

(2) One ton of NO_x from a single source during the term of the permit and 5 tons of NO_x at the facility during the term of the permit.

(3) One and six-tenths tons of the oxides of sulfur from a single source during the term of the permit and 8.0 tons of oxides of sulfur at the facility during the term of the permit.

(4) Six-tenths of a ton of PM₁₀ from a single source during the term of the permit and 3.0 tons of PM₁₀ at the facility during the term of the permit. This shall include emissions of a pollutant regulated under Section 112 of the Clean Air Act unless precluded by the Clean Air Act or 25 Pa. Code Article III.

(5) One ton of VOCs from a single source during the term of the permit and 5.0 tons of VOCs at the facility during the term of the permit. This shall include emissions of a pollutant regulated under Section 112 of the Clean Air Act unless precluded by the Clean Air Act or 25 Pa. Code Article III.

(c) In accordance with § 127.14, the permittee may install the following minor sources without the need for a plan approval:

(1) Air conditioning or ventilation systems not designed to remove pollutants generated or released from other sources.

(2) Combustion units rated at 2,500,000 or less Btu per hour of heat input.

(3) Combustion units with a rated capacity of less than 10,000,000 Btu per hour heat input fueled by natural gas supplied by a public utility, liquefied petroleum gas or by commercial fuel oils which are No. 2 or lighter, viscosity less than or equal to 5.82 c St, and which meet the sulfur content requirements of 25 Pa. Code § 123.22 (relating to combustion units). For purposes of this permit, commercial fuel oil shall be virgin oil which has no reprocessed, recycled or waste material added.

(4) Space heaters which heat by direct heat transfer.

**SECTION B. General Title V Requirements**

(5) Laboratory equipment used exclusively for chemical or physical analysis.

(6) Other sources and classes of sources determined to be of minor significance by the Department.

(d) This permit does not authorize de minimis emission increases if the emissions increase would cause one or more of the following:

(1) Increase the emissions of a pollutant regulated under Section 112 of the Clean Air Act except as authorized in Subparagraphs (b)(4) and (5) of this permit condition.

(2) Subject the facility to the prevention of significant deterioration requirements in 25 Pa. Code Chapter 127, Subchapter D and/or the new source review requirements in Subchapter E.

(3) Violate any applicable requirement of the Air Pollution Control Act, the Clean Air Act, or the regulations promulgated under either of the acts.

(4) Changes which are modifications under any provision of Title I of the Clean Air Act and emission increases which would exceed the allowable emissions level (expressed as a rate of emissions or in terms of total emissions) under the Title V permit.

(e) Unless precluded by the Clean Air Act or the regulations thereunder, the permit shield described in 25 Pa. Code § 127.516 (relating to permit shield) shall extend to the changes made under 25 Pa. Code § 127.449 (relating to de minimis emission increases).

(f) Emissions authorized under this permit condition shall be included in the monitoring, recordkeeping and reporting requirements of this permit.

(g) Except for de minimis emission increases allowed under this permit, 25 Pa. Code § 127.449, or sources and physical changes meeting the requirements of 25 Pa. Code § 127.14, the permittee is prohibited from making physical changes or engaging in activities that are not specifically authorized under this permit without first applying for a plan approval. In accordance with § 127.14(b), a plan approval is not required for the construction, modification, reactivation, or installation of the sources creating the de minimis emissions increase.

(h) The permittee may not meet de minimis emission threshold levels by offsetting emission increases or decreases at the same source.

#020 [25 Pa. Code §§ 127.11a & 127.215]**Reactivation of Sources**

(a) The permittee may reactivate a source at the facility that has been out of operation or production for at least one year, but less than or equal to five (5) years, if the source is reactivated in accordance with the requirements of 25 Pa. Code §§ 127.11a and 127.215. The reactivated source will not be considered a new source.

(b) A source which has been out of operation or production for more than five (5) years but less than 10 years may be reactivated and will not be considered a new source if the permittee satisfies the conditions specified in 25 Pa. Code § 127.11a(b).

#021 [25 Pa. Code §§ 121.9 & 127.216]**Circumvention**

(a) The owner of this Title V facility, or any other person, may not circumvent the new source review requirements of 25 Pa. Code Chapter 127, Subchapter E by causing or allowing a pattern of ownership or development, including the phasing, staging, delaying or engaging in incremental construction, over a geographic area of a facility which, except for the pattern of ownership or development, would otherwise require a permit or submission of a plan approval application.

(b) No person may permit the use of a device, stack height which exceeds good engineering practice stack height, dispersion technique or other technique which, without resulting in reduction of the total amount of air contaminants emitted, conceals or dilutes an emission of air contaminants which would otherwise be in violation of this permit, the Air Pollution Control Act or the regulations promulgated thereunder, except that with prior approval of the Department,

**SECTION B. General Title V Requirements**

the device or technique may be used for control of malodors.

#022 [25 Pa. Code §§ 127.402(d) & 127.513(1)]**Submissions**

(a) Reports, test data, monitoring data, notifications and requests for renewal of the permit shall be submitted to the:

Regional Air Program Manager
PA Department of Environmental Protection
(At the address given on the permit transmittal letter,
or otherwise notified)

(b) Any report or notification for the EPA Administrator or EPA Region III should be addressed to:

Office of Air Enforcement and Compliance Assistance (3AP20)
United States Environmental Protection Agency
Region 3
1650 Arch Street
Philadelphia, PA 19103-2029

(c) An application, form, report or compliance certification submitted pursuant to this permit condition shall contain certification by a responsible official as to truth, accuracy, and completeness as required under 25 Pa. Code § 127.402(d). Unless otherwise required by the Clean Air Act or regulations adopted thereunder, this certification and any other certification required pursuant to this permit shall state that, based on information and belief formed after reasonable inquiry, the statements and information in the document are true, accurate and complete.

#023 [25 Pa. Code §§ 127.441(c) & 127.463(e); Chapter 139; & 114(a)(3), 504(b) of the CAA]**Sampling, Testing and Monitoring Procedures**

(a) The permittee shall perform the emissions monitoring and analysis procedures or test methods for applicable requirements of this Title V permit. In addition to the sampling, testing and monitoring procedures specified in this permit, the Permittee shall comply with any additional applicable requirements promulgated under the Clean Air Act after permit issuance regardless of whether the permit is revised.

(b) The sampling, testing and monitoring required under the applicable requirements of this permit, shall be conducted in accordance with the requirements of 25 Pa. Code Chapter 139 unless alternative methodology is required by the Clean Air Act (including §§ 114(a)(3) and 504(b)) and regulations adopted thereunder.

#024 [25 Pa. Code §§ 127.511 & Chapter 135]**Recordkeeping Requirements**

(a) The permittee shall maintain and make available, upon request by the Department, records of required monitoring information that include the following:

- (1) The date, place (as defined in the permit) and time of sampling or measurements.
- (2) The dates the analyses were performed.
- (3) The company or entity that performed the analyses.
- (4) The analytical techniques or methods used.
- (5) The results of the analyses.
- (6) The operating conditions as existing at the time of sampling or measurement.

(b) The permittee shall retain records of the required monitoring data and supporting information for at least five (5) years from the date of the monitoring sample, measurement, report or application. Supporting information includes the calibration data and maintenance records and original strip-chart recordings for continuous monitoring instrumentation, and copies of reports required by the permit.

**SECTION B. General Title V Requirements**

(c) The permittee shall maintain and make available to the Department upon request, records including computerized records that may be necessary to comply with the reporting, recordkeeping and emission statement requirements in 25 Pa. Code Chapter 135 (relating to reporting of sources). In accordance with 25 Pa. Code Chapter 135, § 135.5, such records may include records of production, fuel usage, maintenance of production or pollution control equipment or other information determined by the Department to be necessary for identification and quantification of potential and actual air contaminant emissions. If direct recordkeeping is not possible or practical, sufficient records shall be kept to provide the needed information by indirect means.

#025 [25 Pa. Code §§ 127.411(d), 127.442, 127.463(e) & 127.511(c)]**Reporting Requirements**

(a) The permittee shall comply with the reporting requirements for the applicable requirements specified in this Title V permit. In addition to the reporting requirements specified herein, the permittee shall comply with any additional applicable reporting requirements promulgated under the Clean Air Act after permit issuance regardless of whether the permit is revised.

(b) Pursuant to 25 Pa. Code § 127.511(c), the permittee shall submit reports of required monitoring at least every six (6) months unless otherwise specified in this permit. Instances of deviations (as defined in 25 Pa. Code § 121.1) from permit requirements shall be clearly identified in the reports. The reporting of deviations shall include the probable cause of the deviations and corrective actions or preventative measures taken, except that sources with continuous emission monitoring systems shall report according to the protocol established and approved by the Department for the source. The required reports shall be certified by a responsible official.

(c) Every report submitted to the Department under this permit condition shall comply with the submission procedures specified in Section B, Condition #022(c) of this permit.

(d) Any records, reports or information obtained by the Department or referred to in a public hearing shall be made available to the public by the Department except for such records, reports or information for which the permittee has shown cause that the documents should be considered confidential and protected from disclosure to the public under Section 4013.2 of the Air Pollution Control Act and consistent with Sections 112(d) and 114(c) of the Clean Air Act and 25 Pa. Code § 127.411(d). The permittee may not request a claim of confidentiality for any emissions data generated for the Title V facility.

#026 [25 Pa. Code § 127.513]**Compliance Certification**

(a) One year after the date of issuance of the Title V permit, and each year thereafter, unless specified elsewhere in the permit, the permittee shall submit to the Department and EPA Region III a certificate of compliance with the terms and conditions in this permit, for the previous year, including the emission limitations, standards or work practices. This certification shall include:

- (1) The identification of each term or condition of the permit that is the basis of the certification.
- (2) The compliance status.
- (3) The methods used for determining the compliance status of the source, currently and over the reporting period.
- (4) Whether compliance was continuous or intermittent.

(b) The compliance certification shall be postmarked or hand-delivered no later than thirty days after each anniversary of the date of issuance of this Title V Operating Permit, or on the submittal date specified elsewhere in the permit, to the Department and EPA in accordance with the submission requirements specified in condition #022 of this section.

#027 [25 Pa. Code § 127.3]**Operational Flexibility**

The permittee is authorized to make changes within the Title V facility in accordance with the following provisions in 25 Pa. Code Chapter 127 which implement the operational flexibility requirements of Section 502(b)(10) of the Clean Air Act and Section 6.1(i) of the Air Pollution Control Act:

- (1) Section 127.14 (relating to exemptions)

**SECTION B. General Title V Requirements**

- (2) Section 127.447 (relating to alternative operating scenarios)
- (3) Section 127.448 (relating to emissions trading at facilities with federally enforceable emissions caps)
- (4) Section 127.449 (relating to de minimis emission increases)
- (5) Section 127.450 (relating to administrative operating permit amendments)
- (6) Section 127.462 (relating to minor operating permit amendments)
- (7) Subchapter H (relating to general plan approvals and operating permits)

#028 [25 Pa. Code §§ 127.441(d), 127.512(i) and 40 CFR Part 68]**Risk Management**

(a) If required by Section 112(r) of the Clean Air Act, the permittee shall develop and implement an accidental release program consistent with requirements of the Clean Air Act, 40 CFR Part 68 (relating to chemical accident prevention provisions) and the Federal Chemical Safety Information, Site Security and Fuels Regulatory Relief Act (P.L. 106-40).

(b) The permittee shall prepare and implement a Risk Management Plan (RMP) which meets the requirements of Section 112(r) of the Clean Air Act, 40 CFR Part 68 and the Federal Chemical Safety Information, Site Security and Fuels Regulatory Relief Act when a regulated substance listed in 40 CFR § 68.130 is present in a process in more than the listed threshold quantity at the Title V facility. The permittee shall submit the RMP to the federal Environmental Protection Agency according to the following schedule and requirements:

(1) The permittee shall submit the first RMP to a central point specified by EPA no later than the latest of the following:

- (i) Three years after the date on which a regulated substance is first listed under § 68.130; or,
- (ii) The date on which a regulated substance is first present above a threshold quantity in a process.

(2) The permittee shall submit any additional relevant information requested by the Department or EPA concerning the RMP and shall make subsequent submissions of RMPs in accordance with 40 CFR § 68.190.

(3) The permittee shall certify that the RMP is accurate and complete in accordance with the requirements of 40 CFR Part 68, including a checklist addressing the required elements of a complete RMP.

(c) As used in this permit condition, the term "process" shall be as defined in 40 CFR § 68.3. The term "process" means any activity involving a regulated substance including any use, storage, manufacturing, handling, or on-site movement of such substances or any combination of these activities. For purposes of this definition, any group of vessels that are interconnected, or separate vessels that are located such that a regulated substance could be involved in a potential release, shall be considered a single process.

(d) If the Title V facility is subject to 40 CFR Part 68, as part of the certification required under this permit, the permittee shall:

(1) Submit a compliance schedule for satisfying the requirements of 40 CFR Part 68 by the date specified in 40 CFR § 68.10(a); or,

(2) Certify that the Title V facility is in compliance with all requirements of 40 CFR Part 68 including the registration and submission of the RMP.

(e) If the Title V facility is subject to 40 CFR Part 68, the permittee shall maintain records supporting the implementation of an accidental release program for five (5) years in accordance with 40 CFR § 68.200.

(f) When the Title V facility is subject to the accidental release program requirements of Section 112(r) of the Clean Air Act and 40 CFR Part 68, appropriate enforcement action will be taken by the Department if:

- (1) The permittee fails to register and submit the RMP or a revised plan pursuant to 40 CFR Part 68.

**SECTION B. General Title V Requirements**

(2) The permittee fails to submit a compliance schedule or include a statement in the compliance certification required under Condition #26 of Section B of this Title V permit that the Title V facility is in compliance with the requirements of Section 112(r) of the Clean Air Act, 40 CFR Part 68, and 25 Pa. Code § 127.512(i).

#029 [25 Pa. Code § 127.512(e)]**Approved Economic Incentives and Emission Trading Programs**

No permit revision shall be required under approved economic incentives, marketable permits, emissions trading and other similar programs or processes for changes that are provided for in this Title V permit.

#030 [25 Pa. Code §§ 127.516, 127.450(d), 127.449(f) & 127.462(g)]**Permit Shield**

(a) The permittee's compliance with the conditions of this permit shall be deemed in compliance with applicable requirements (as defined in 25 Pa. Code § 121.1) as of the date of permit issuance if either of the following applies:

(1) The applicable requirements are included and are specifically identified in this permit.

(2) The Department specifically identifies in the permit other requirements that are not applicable to the permitted facility or source.

(b) Nothing in 25 Pa. Code § 127.516 or the Title V permit shall alter or affect the following:

(1) The provisions of Section 303 of the Clean Air Act, including the authority of the Administrator of the EPA provided thereunder.

(2) The liability of the permittee for a violation of an applicable requirement prior to the time of permit issuance.

(3) The applicable requirements of the acid rain program, consistent with Section 408(a) of the Clean Air Act.

(4) The ability of the EPA to obtain information from the permittee under Section 114 of the Clean Air Act.

(c) Unless precluded by the Clean Air Act or regulations thereunder, final action by the Department incorporating a significant permit modification in this Title V Permit shall be covered by the permit shield at the time that the permit containing the significant modification is issued.

**SECTION C. Site Level Requirements****I. RESTRICTIONS.****Emission Restriction(s).****# 001 [25 Pa. Code §121.7]****Prohibition of air pollution.**

No person may permit air pollution as that term is defined in the act.

002 [25 Pa. Code §123.1]**Prohibition of certain fugitive emissions**

(a) No person may permit the emission into the outdoor atmosphere of fugitive air contaminant from a source other than the following:

- (1) Construction or demolition of buildings or structures.
- (2) Grading, paving and maintenance of roads and streets.
- (3) Use of roads and streets. Emissions from material in or on trucks, railroad cars and other vehicular equipment are not considered as emissions from use of roads and streets.
- (4) Clearing of land.
- (5) Stockpiling of materials.
- (6) Open burning operations.
- (7)-(8) Not applicable.

(9) Sources and classes of sources other than those identified in paragraphs (1)-(6), for which the operator has obtained a determination from the Department that fugitive emissions from the source, after appropriate control, meet the following requirements:

- (i) the emissions are of minor significance with respect to causing air pollution; and
- (ii) the emissions are not preventing or interfering with the attainment or maintenance of any ambient air quality standard.

(b) An application form for requesting a determination under either subsection (a)(9) or 129.15(c) is available from the Department. In reviewing these applications, the Department may require the applicant to supply information including, but not limited to, a description of proposed control measures, characteristics of emissions, quantity of emissions, and ambient air quality data and analysis showing the impact of the source on ambient air quality. The applicant shall be required to demonstrate that the requirements of subsections (a)(9) and (c) and 123.2 (relating to fugitive particulate matter) or of the requirements of 129.15(c) have been satisfied. Upon such demonstration, the Department will issue a determination, in writing, either as an operating permit condition, for those sources subject to permit requirements under the act, or as an order containing appropriate conditions and limitations.

- (c) See Work Practice Requirements.
- (d) Not applicable.

003 [25 Pa. Code §123.2]**Fugitive particulate matter**

A person may not permit fugitive particulate matter to be emitted into the outdoor atmosphere from a source specified in 123.1(a)(1) -- (9) (relating to prohibition of certain fugitive emissions) if such emissions are visible at the point the emissions pass outside the person's property.

004 [25 Pa. Code §123.31]**Limitations**

(a) Limitations are as follows:

(1) If control of malodorous air contaminants is required under subsection (b), emissions shall be incinerated at a minimum of 1200F for at least 0.3 seconds prior to their emission into the outdoor atmosphere.

(2) Techniques other than incineration may be used to control malodorous air contaminants if such techniques are equivalent to or better than the required incineration in terms of control of the odor emissions and are approved in writing by the Department.

(b) A person may not permit the emission into the outdoor atmosphere of any malodorous air contaminants from any source in such a manner that the malodors are detectable outside the property of the person on whose land the source is

**SECTION C. Site Level Requirements**

being operated.

(c) The prohibition in subsection (b) does not apply to odor emissions arising from the production of agricultural commodities in their unmanufactured state on the premises of the farm operation.

005 [25 Pa. Code §123.41]**Limitations**

A person may not permit the emission into the outdoor atmosphere of visible air contaminants in such a manner that the opacity of the emission is either of the following:

- (1) Equal to or greater than 20% for a period or periods aggregating more than three minutes in any 1 hour.
- (2) Equal to or greater than 60% at any time.

006 [25 Pa. Code §123.42]**Exceptions**

The limitations of 123.41 (relating to limitations) shall not apply to a visible emission in any of the following instances:

- (1) When the presence of uncombined water is the only reason for failure of the emission to meet the limitations.
- (2) When the emission results from the operation of equipment used solely to train and test persons in observing the opacity of visible emissions.
- (3) When the emission results from sources specified in 123.1(a)(1) -- (9) (relating to prohibition of certain fugitive emissions).
- (4) When arising from the production of agricultural commodities in their unmanufactured state on the premises of the farm operation.

007 [25 Pa. Code §127.441]**Operating permit terms and conditions.**

VOC emissions from this facility shall not exceed 102.8 tons per year rolled monthly.

008 [25 Pa. Code §129.14]**Open burning operations**

- (a) Air basins. No person may permit the open burning of material in an air basin.
- (b) Outside of air basins. No person may permit the open burning of material in an area outside of air basins in a manner that:
 - (1) The emissions are visible, at any time, at the point such emissions pass outside the property of the person on whose land the open burning is being conducted.
 - (2) Malodorous air contaminants from the open burning are detectable outside the property of the person on whose land the open burning is being conducted.
 - (3) The emissions interfere with the reasonable enjoyment of life or property.
 - (4) The emissions cause damage to vegetation or property.
 - (5) The emissions are or may be deleterious to human or animal health.
- (c) Exceptions: The requirements of subsections (a) and (b) do not apply where the open burning operations result from:
 - (1) A fire set to prevent or abate a fire hazard, when approved by the Department and set by or under the supervision of a public officer.
 - (2) A fire set for the purpose of instructing personnel in fire fighting, when approved by the Department.
 - (3) A fire set for the prevention and control of disease or pests, when approved by the Department.
 - (4) A fire set in conjunction with the production of agricultural commodities in their unmanufactured state on the premises of the farm operation.
 - (5) A fire set for the purpose of burning domestic refuse, when the fire is on the premises of a structure occupied solely as a dwelling by two families or less and when the refuse results from the normal occupancy of such structure.

**SECTION C. Site Level Requirements**

- (6) A fire set solely for recreational or ceremonial purposes.
- (7) A fire set solely for cooking food.

(d) Clearing and grubbing wastes. The following is applicable to clearing and grubbing wastes:

- (1) As used in this subsection the following terms shall have the following meanings:

Air curtain destructor -- A mechanical device which forcefully projects a curtain of air across a pit in which open burning is being conducted so that combustion efficiency is increased and smoke and other particulate matter are contained.

Clearing and grubbing wastes -- Trees, shrubs, and other native vegetation which are cleared from land during or prior to the process of construction. The term does not include demolition wastes and dirt laden roots.

(2) Subsection (a) notwithstanding, clearing and grubbing wastes may be burned in a basin subject to the following requirements:

- (i) Air curtain destructors shall be used when burning clearing and grubbing wastes.
- (ii) Each proposed use of air curtain destructors shall be reviewed and approved by the Department in writing with respect to equipment arrangement, design and existing environmental conditions prior to commencement of burning. Proposals approved under this subparagraph need not obtain plan approval or operating permits under Chapter 127 (relating to construction modification, reactivation and operation of sources).
- (iii) Approval for use of an air curtain destructor at one site may be granted for a specified period not to exceed 3 months, but may be extended for additional limited periods upon further approval by the Department.
- (iv) The Department reserves the right to rescind approval granted if a determination by the Department indicates that an air pollution problem exists.

(3) Subsection (b) notwithstanding clearing and grubbing wastes may be burned outside of an air basin, subject to the following limitations:

- (i) Upon receipt of a complaint or determination by the Department that an air pollution problem exists, the Department may order that the open burning cease or comply with subsection (b) of this section.
- (ii) Authorization for open burning under this paragraph does not apply to clearing and grubbing wastes transported from an air basin for disposal outside of an air basin.

(4) During an air pollution episode, open burning is limited by Chapter 137 (relating to air pollution episodes) and shall cease as specified in such chapter.

II. TESTING REQUIREMENTS.

No additional testing requirements exist except as provided in other sections of this permit including Section B (Title V General Requirements).

III. MONITORING REQUIREMENTS.**# 009 [25 Pa. Code §123.43]****Measuring techniques**

Visible emissions may be measured using either of the following:

- (1) A device approved by the Department and maintained to provide accurate opacity measurements.
- (2) Observers, trained and qualified to measure plume opacity with the naked eye or with the aid of any devices approved by the Department.

010 [25 Pa. Code §127.511]**Monitoring and related recordkeeping and reporting requirements.**

**SECTION C. Site Level Requirements**

A facility-wide inspection shall be conducted at a minimum of once each day that facility is in operation. The facility-wide inspection shall be conducted for the presence of the following:

- (a) Visible stack emissions;
- (b) Fugitive emissions; and
- (c) Potentially objectionable odors at the property line.

These observations are to ensure continued compliance with source-specific visible emission limitations, fugitive emissions prohibited under 25 Pa.Code Sections 123.1 or 123.2, and malodors prohibited under 25 Pa. Code Section 123.31. Observations for visible stack emissions shall be conducted during daylight hours and all observations shall be conducted while sources are in operation. If visible stack emissions, fugitive emissions, or potentially objective odors are apparent, the Owner/Operator shall take corrective action.

011 [25 Pa. Code §127.511]**Monitoring and related recordkeeping and reporting requirements.**

(a) For sources that emit air contaminants solely from natural gas combustion, the permittee shall verify compliance with the opacity standards of 123.41 or any alternative applicable opacity requirement through:

- (i) quarterly fuel sampling and analysis, or
- (ii) certification from fuel supplier verifying the use of pipeline-grade gas.

IV. RECORDKEEPING REQUIREMENTS.**# 012 [25 Pa. Code §127.441]****Operating permit terms and conditions.**

In accordance with Operating Permit 63-000-015, Condition No.4, the Owner/Operator shall maintain records in accordance with 25 PA Code Ch. 129.95. At a minimum, the following records shall be kept at the facility on a monthly basis: natural gas consumption and Crystex production. These records shall be maintained on file for not less than five years and shall be made available to the Department upon request.

013 [25 Pa. Code §127.511]**Monitoring and related recordkeeping and reporting requirements.**

Records of daily inspections for visible stack emissions, fugitive emissions, and potentially objectionable odors at the property line shall be maintained for a minimum of five (5) years and include the date, time, name and title of the observer, whether or not any stack emissions, fugitive emissions, or potentially objectionable odors at the property line were observed, and any corrective action taken. Records shall be made available to the Department upon request.

014 [25 Pa. Code §135.5]**Recordkeeping**

Source owners or operators shall maintain and make available upon request by the Department records including computerized records that may be necessary to comply with § § 135.3 and 135.21 (relating to reporting; and emission statements). These may include records of production, fuel usage, maintenance of production or pollution control equipment or other information determined by the Department to be necessary for identification and quantification of potential and actual air contaminant emissions. If direct recordkeeping is not possible or practical, sufficient records shall be kept to provide the needed information by indirect means.

V. REPORTING REQUIREMENTS.**# 015 [25 Pa. Code §127.442]****Reporting requirements.**

Malfunction reporting shall be conducted as follows:

- (a) For the purpose of this condition, a malfunction is defined as any sudden, infrequent, and not reasonably preventable

**SECTION C. Site Level Requirements**

failure of air pollution control equipment or source to operate in a normal or usual manner that may result in an increase in the emissions of air contaminants. Examples of malfunctions may include, but are not limited to: large dust plumes, heavy smoke, a spill or release that results in a malodor that is detectable outside the property on whose land the source is being operated.

(b) Any malfunction that poses an imminent danger to the public health, safety, or welfare to the environment shall be reported by telephone to the County Emergency Management Agency (911 Center), and to the 24-hour Emergency Hotline of the appropriate Department Regional Office (412-442-4000) no later than one hour after the discovery of an incident. Following the telephone notification, a written notice shall be submitted to the Department no later than the next business day.

(c) All other malfunctions shall be reported to the Department no later than the next business day.

(d) Initial reporting of the malfunction shall identify the following items to the extent known:

- (i) The name and location of the facility;
- (ii) The nature and cause of the malfunction;
- (iii) The time when the malfunction or breakdown was first observed;
- (iv) The expected duration of increased emissions; and
- (v) The estimated rate of emissions.

(e) The Owner or Operator shall also notify the Department immediately, by telephone, when corrective measures for malfunctions meeting the criteria in (b) have been accomplished.

(f) All malfunctions shall be reported to the Department by email (addresses will be provided by the Department), or by regular mail at the address below:

PADEP
Office of Air Quality
400 Waterfront Drive
Pittsburgh, PA 15222-4745
(412) 442-4000

(g) If requested by the Department, the Owner/Operator shall submit a full written report to the Department, including final determinations of the items identified in (d), and the corrective measures taken on the malfunction. The report shall be submitted within 15 days of the Department's request or accomplishing corrective measures, whichever is later.

016 [25 Pa. Code §127.511]**Monitoring and related recordkeeping and reporting requirements.**

The semi-annual deviation report, required under Section B Condition #023, shall be submitted to the Department within 30-days of the end of the reporting period. The 6-month deviation report shall cover the following periods unless otherwise approved by the Department:

1. January 1 through June 30
2. July 1 through December 31

The annual compliance certification report, required under Section B Condition #024, shall be submitted to both the Department and EPA Region III within 30-days of the end of the reporting period. The annual compliance certification shall cover the period of January 1 through the last day of December of each year unless otherwise approved by the Department.

017 [25 Pa. Code §135.21]**Emission statements**

(a) Except as provided in subsection (d), this section applies to stationary sources or facilities:

- (1) Located in an area designated by the Clean Air Act as a marginal, moderate, serious, severe or extreme ozone

**SECTION C. Site Level Requirements**

nonattainment area and which emit oxides of nitrogen or VOC.

(2) Not located in an area described in subparagraph (1) and included in the Northeast Ozone Transport Region which emit or have the potential to emit 100 tons or more oxides of nitrogen or 50 tons or more of VOC per year.

(b) The owner or operator of each stationary source emitting oxides of nitrogen or VOC's shall provide the Department with a statement, in a form as the Department may prescribe, for classes or categories of sources, showing the actual emissions of oxides of nitrogen and VOCs from that source for each reporting period, a description of the method used to calculate the emissions and the time period over which the calculation is based. The statement shall contain a certification by a company officer or the plant manager that the information contained in the statement is accurate.

(c) Annual emission statements are due by March 1 for the preceding calendar year beginning with March 1, 1993, for calendar year 1992 and shall provide data consistent with requirements and guidance developed by the EPA. The guidance document is available from: United States Environmental Protection Agency, 401 M. Street, S.W., Washington, D.C. 20460. The Department may require more frequent submittals if the Department determines that one or more of the following applies:

- (1) A more frequent submission is required by the EPA.
- (2) Analysis of the data on a more frequent basis is necessary to implement the requirements of the act.

(d) Subsection (a) does not apply to a class or category of stationary sources which emits less than 25 tons per year of VOC's or oxides of nitrogen, if the Department in its submissions to the Administrator of the EPA under section 182(a)(1) or (3)(B)(ii) of the Clean Air Act (42 U.S.C.A. 7511a(a)(1) or (3)(B)(ii)) provides an inventory of emissions from the class or category of sources based on the use of the emission factors established by the Administrator or other methods acceptable to the Administrator. The Department will publish in the Pennsylvania Bulletin a notice of the lists of classes or categories of sources which are exempt from the emission statement requirement under this subsection.

018 [25 Pa. Code §135.3]**Reporting**

(a) A person who owns or operates a source to which this chapter applies, and who has previously been advised by the Department to submit a source report, shall submit by March 1 of each year a source report for the preceding calendar year. The report shall include information for all previously reported sources, new sources which were first operated during the preceding calendar year and sources modified during the same period which were not previously reported.

(b) A person who receives initial notification by the Department that a source report is necessary shall submit an initial source report within 60 days after receiving the notification or by March 1 of the year following the year for which the report is required, whichever is later.

(c) A source owner or operator may request an extension of time from the Department for the filing of a source report, and the Department may grant the extension for reasonable cause.

VI. WORK PRACTICE REQUIREMENTS.**# 019 [25 Pa. Code §123.1]****Prohibition of certain fugitive emissions**

(c) A person responsible for any source specified in subsections (a)(1) -- (6) or (9) in Section C, Condition #002 of this permit shall take all reasonable actions to prevent particulate matter from becoming airborne. These actions shall include, but not be limited to, the following:

- (1) Use, where possible, of water or chemicals for control of dust in the demolition of buildings or structures, construction operations, the grading of roads, or the clearing of land.
- (2) Application of asphalt, oil, water or suitable chemicals on dirt roads, material stockpiles and other surfaces which may give rise to airborne dusts.
- (3) Paving and maintenance of roadways.
- (4) Prompt removal of earth or other material from paved streets onto which earth or other material has been transported by trucking or earth moving equipment, erosion by water, or other means.

**SECTION C. Site Level Requirements****VII. ADDITIONAL REQUIREMENTS.****# 020 [25 Pa. Code §129.96]****Applicability**

(a) The NO_x requirements of this section and § § 129.97—129.100 apply Statewide to the owner and operator of a major NO_x emitting facility and the VOC requirements of this section and § § 129.97—129.100 apply Statewide to the owner and operator of a major VOC emitting facility that were in existence on or before July 20, 2012, for which a requirement or emission limitation, or both, has not been established in § § 129.51—129.52c, 129.54—129.69, 129.71—129.73, 129.75, 129.77, 129.101—129.107 and 129.301—129.310.

(b) Not applicable.

(c) This section and § § 129.97—129.100 do not apply to the owner and operator of a NO_x air contamination source located at a major NO_x emitting facility that has the potential to emit less than 1 TPY of NO_x or a VOC air contamination source located at a major VOC emitting facility that has the potential to emit less than 1 TPY of VOC.

(d) Not applicable.

021 [25 Pa. Code §137.4]**Standby plans**

(a) This section applies to the following classes of sources located in the counties identified in subsection (b):

(1)-(2) Not applicable.

(3) Manufacturing industries of the following classifications which employ more than 20 employees at any one location:

(i)-(ii) Not applicable.

(iii) Chemical and allied products industries.

(iv)-(v) Not applicable.

(b) The Department will annually classify each county as an area requiring a standby plan based on monitored exceedance of any of the NAAQS.

(c) Any person responsible for the operation of a facility in subsection (a) and located in a county classified in subsection (b) as requiring a standby plan shall submit standby plans for reducing the emission of air contaminants from that facility during alert, warning and emergency levels to the Department within 90 days of the Department's request. The plans shall be designed to reduce or eliminate the emissions of air contaminants in accordance with the objectives in §§ 137.11-137.14 (relating to level actions). The plans shall be in writing on forms published and distributed by the Department and shall identify the approximate amount of reduction of various air contaminants and a description of the manner in which the reductions will be achieved.

(d) If the Department determines that a standby plan does not provide for effectively achieving the objectives in §§ 137.11-137.14, the Department may disapprove the plan, state its reasons for the disapproval and either order the preparation of an amended plan within a time period specified in the order or issue, by order, a plan to replace the disapproved plan.

(e) The Department may amend or otherwise change a standby plan if it determines that good cause exists for the action. An amendment or change will be in writing and will be accompanied by a notice of sufficient cause for the action.

(f) For facilities required to submit standby plans under subsection (e), during a forecast, alert, warning or emergency level, the standby plan shall be made available by the person responsible for the facility to employees of the Department on the premises of the source.

VIII. COMPLIANCE CERTIFICATION.

No additional compliance certifications exist except as provided in other sections of this permit including Section B (relating to Title V General Requirements).

IX. COMPLIANCE SCHEDULE.



SECTION C. Site Level Requirements

No compliance milestones exist.

***** Permit Shield In Effect *****

**SECTION D. Source Level Requirements**

Source ID: 034

Source Name: BOILER #1

Source Capacity/Throughput:	25.100 MMBTU/HR	
	24.100 MCF/HR	Natural Gas
	178.000 Gal/HR	#2 Oil

Conditions for this source occur in the following groups: G02

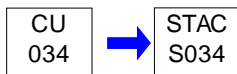
**I. RESTRICTIONS.****Emission Restriction(s).****# 001 [25 Pa. Code §123.11]****Combustion units**

(a) A person may not permit the emission into the outdoor atmosphere of particulate matter from a combustion unit in excess of the following:

(1) The rate of 0.4 pound per million Btu of heat input, when the heat input to the combustion unit in millions of Btus per hour is greater than 2.5 but less than 50.

(2)-(3) Not applicable.

(b) Not applicable.

002 [25 Pa. Code §123.22]**Combustion units**

(a)-(c) Not applicable.

(d) Allegheny County, Lower Beaver Valley, and Monongahela Valley air basins. Combustion units in these subject air basins must conform with the following:

(1) General provision. A person may not permit the emission into the outdoor atmosphere of sulfur oxides, expressed as SO₂, from a combustion unit in excess of one or more of the following:

(i) The rate of 1 pound per million Btu of heat input, when the heat input to the combustion unit in millions of Btus per hour is greater than 2.5 but less than 50.

(ii)-(iii) Not applicable.

(2) Commercial fuel oil.

(i) Except as specified in subparagraphs (ii) and (iii), a person may not offer for sale, deliver for use, exchange in trade or permit the use of commercial fuel oil in the subject air basins on or after July 1, 2016, if the commercial fuel oil contains sulfur in excess of the applicable maximum allowable sulfur content set forth in the following table:

Maximum Allowable Sulfur Content Beginning July 1, 2016,
Expressed as Parts per Million (ppm) by Weight or Percentage by Weight

Grades Commercial Fuel Oil (Consistent with ASTM D396)

No. 2 and lighter oil 500 ppm (0.05%)

No. 4 oil 2,500 ppm (0.25%)

No. 5, No. 6 and heavier oil 5,000 ppm (0.5%)

**SECTION D. Source Level Requirements**

(ii) Commercial fuel oil that was stored in this Commonwealth by the ultimate consumer prior to July 1, 2016, which met the applicable maximum allowable sulfur content at the time it was stored, may be used by the ultimate consumer in this Commonwealth on and after July 1, 2016.

(iii) Beginning July 1, 2016, the Department may temporarily suspend or increase the applicable maximum allowable sulfur content for a commercial fuel oil set forth in subparagraph (i) if the following occur:

(A) The Department receives a written request at the address specified in subsection (h) for a suspension or increase on the basis that compliant commercial fuel oil is not reasonably available in a subject air basin. The request must include the following:

(I) The subject air basin for which the suspension or increase is requested.

(II) The reason compliant commercial fuel oil is not reasonably available.

(III) The duration of time for which the suspension or increase is requested and the justification for the requested duration.

(B) The Department determines that an insufficient quantity of compliant commercial fuel oil is reasonably available in the air basin and that the circumstances leading to the insufficiency are due to events that could not have been reasonably foreseen or prevented and are not due to lack of prudent planning on the part of the transferor of the commercial fuel oil into or within the air basin.

(C) The Department approves the request, in writing, prior to the transferor distributing the noncompliant commercial fuel oil into or within the air basin.

(iv) The Department will limit a suspension or increase in the applicable maximum allowable sulfur content granted under subparagraph (iii) to the shortest duration in which adequate supplies of compliant commercial fuel oil can be made reasonably available, but in no case longer than 60 days from the date the Department grants the suspension or increase.

(3) Equivalency provision. Paragraph (2) does not apply to a person who uses equipment or a process, or to the owner or operator of an installation where equipment or a process is used, to reduce the sulfur emissions from the burning of a fuel with a higher sulfur content than that specified in paragraph (2). The emissions may not exceed those which would result from the use of commercial fuel oil that meets the applicable maximum allowable sulfur content specified in paragraph (2).

(e) Not applicable.

**# 003 [40 CFR Part 60 Standards of Performance for New Stationary Sources §40 CFR 60.42c]
Subpart Dc - Standards of Performance for Small Industrial- Commercial-Institutional Steam Generating Units
Standard for sulfur dioxide.**

(a)-(c) Not applicable.

(d) On and after the date on which the initial performance test is completed or required to be completed under §60.8, whichever date comes first, no owner or operator of an affected facility that combusts oil shall cause to be discharged into the atmosphere from that affected facility any gases that contain SO₂ in excess of 215 ng/J (0.50 lb/MMBtu) heat input from oil; or, as an alternative, no owner or operator of an affected facility that combusts oil shall combust oil in the affected facility that contains greater than 0.5 weight percent sulfur. The percent reduction requirements are not applicable to affected facilities under this paragraph.

(e)-(f) Not applicable.

(h) For affected facilities listed under paragraphs (h)(1), (2), (3), or (4) of this section, compliance with the emission limits or fuel oil sulfur limits under this section may be determined based on a certification from the fuel supplier, as described under §60.48c(f), as applicable.

(1) Distillate oil-fired affected facilities with heat input capacities between 2.9 and 29 MW (10 and 100 MMBtu/hr).

(2)-(4) Not applicable.

**SECTION D. Source Level Requirements**

(i) The SO₂ emission limits, fuel oil sulfur limits, and percent reduction requirements under this section apply at all times, including periods of startup, shutdown, and malfunction.

(j) Not applicable.

II. TESTING REQUIREMENTS.

No additional testing requirements exist except as provided in other sections of this permit including Section B (Title V General Requirements) and/or Section E (Source Group Restrictions).

III. MONITORING REQUIREMENTS.

No additional monitoring requirements exist except as provided in other sections of this permit including Section B (Title V General Requirements) and/or Section E (Source Group Restrictions).

IV. RECORDKEEPING REQUIREMENTS.**# 004 [25 Pa. Code §127.511]****Monitoring and related recordkeeping and reporting requirements.**

The Owner/Operator shall maintain records of natural gas and fuel oil usage on a monthly basis for the above boilers for the purpose of determining compliance with the applicable emission restrictions within this operating permit.

005 [25 Pa. Code §127.511]**Monitoring and related recordkeeping and reporting requirements.**

The Owner/Operator shall maintain records containing at a minimum, a Certification of sulfur content in the fuel oil used from the supplier and a Certification of sulfur content in the natural gas utilized in these boilers.

006 [25 Pa. Code §129.100]**Compliance demonstration and recordkeeping requirements.**

(a) - (c) Not applicable.

(d) The owner and operator of an air contamination source subject to this section and §§ 129.96—129.99 shall keep records to demonstrate compliance with §§ 129.96—129.99 in the following manner:

(1) The records must include sufficient data and calculations to demonstrate that the requirements of §§ 129.96—129.99 are met.

(2) Data or information required to determine compliance shall be recorded and maintained in a time frame consistent with the averaging period of the requirement.

(e) Not applicable.

(f) Not applicable.

(g) The owner or operator of a combustion unit subject to § 129.97(b) shall record each adjustment conducted under the procedures in § 129.97(b). This record must contain, at a minimum:

(1) The date of the tuning procedure.

(2) The name of the service company and the technician performing the procedure.

(3) The final operating rate or load.

**SECTION D. Source Level Requirements**

- (4) The final NO_x and CO emission rates.
- (5) The final excess oxygen rate.
- (6) Other information required by the applicable operating permit.
- (h) Not applicable.
- (i) The records shall be retained by the owner or operator for 5 years and made available to the Department or appropriate approved local air pollution control agency upon receipt of a written request from the Department or appropriate approved local air pollution agency.

007 [40 CFR Part 60 Standards of Performance for New Stationary Sources §40 CFR 60.48c]
Subpart Dc - Standards of Performance for Small Industrial- Commercial-Institutional Steam Generating Units
Reporting and recordkeeping requirements.

In accordance with 40 CFR 60.48c (e), the permittee shall maintain records of fuel supplier certification to include the following information;

- (i) the name of the oil supplier
- (ii) a statement from the supplier that the oil complies with the specifications for fuel oil numbers 1 or 2, as defined in ASTM D396-78.

008 [40 CFR Part 60 Standards of Performance for New Stationary Sources §40 CFR 60.7]
Subpart A - General Provisions
Notification and record keeping.

(a) Any owner or operator subject to the provisions of this part shall furnish the Administrator written notification as follows:

(1)-(3) Not applicable.

(4) A notification of any physical or operational change to an existing facility which may increase the emission rate of any air pollutant to which a standard applies, unless that change is specifically exempted under an applicable subpart or in 60.14(e). This notice shall be postmarked 60 days or as soon as practicable before the change is commenced and shall include information describing the precise nature of the change, present and proposed emission control systems, productive capacity of the facility before and after the change, and the expected completion date of the change. The Administrator may request additional relevant information subsequent to this notice.

(5)-(7) Not applicable.

(b) Any owner or operator subject to the provisions of this part shall maintain records of the occurrence and duration of any startup, shutdown, or malfunction in the operation of an affected facility; any malfunction of the air pollution control equipment; or any periods during which a continuous monitoring system or monitoring device is inoperative.

(c)-(d) Not applicable.

(e)(1) Not applicable

(2) The frequency of reporting of excess emissions and monitoring systems performance (and summary) reports may be reduced only after the owner or operator notifies the Administrator in writing of his or her intention to make such a change and the Administrator does not object to the intended change. In deciding whether to approve a reduced frequency of reporting, the Administrator may review information concerning the source's entire previous performance history during the required recordkeeping period prior to the intended change, including performance test results, monitoring data, and evaluations of an owner or operator's conformance with operation and maintenance requirements. Such information may be used by the Administrator to make a judgment about the source's potential for noncompliance in the future. If the Administrator disapproves the owner or operator's request to reduce the frequency of reporting, the Administrator will notify

**SECTION D. Source Level Requirements**

the owner or operator in writing within 45 days after receiving notice of the owner or operator's intention. The notification from the Administrator to the owner or operator will specify the grounds on which the disapproval is based. In the absence of a notice of disapproval within 45 days, approval is automatically granted.

(3) Not applicable.

(f) Not applicable.

(g) If notification substantially similar to that in paragraph (a) of this section is required by any other State or local agency, sending the Administrator a copy of that notification will satisfy the requirements of paragraph (a) of this section.

(h) Individual subparts of this part may include specific provisions which clarify or make inapplicable the provisions set forth in this section.

009 [40 CFR Part 63 NESHAPS for Source Categories §40 CFR 63.7555]

Subpart DDDDD - National Emission Standards for Hazardous Air Pollutants for Major Sources: Industrial, Commercial and Institutional Boilers and Process Heaters.

What records must I keep?

(a) You must keep records according to paragraphs (a)(1) and (2) of this section.

(1) A copy of each notification and report that you submitted to comply with this subpart, including all documentation supporting any Initial Notification or Notification of Compliance Status or semiannual compliance report that you submitted, according to the requirements in §63.10(b)(2)(xiv).

(2) Records of performance tests, fuel analyses, or other compliance demonstrations and performance evaluations as required in §63.10(b)(2)(viii).

(3) Not applicable.

(b) - (h) Not applicable.

010 [40 CFR Part 63 NESHAPS for Source Categories §40 CFR 63.7560]

Subpart DDDDD - National Emission Standards for Hazardous Air Pollutants for Major Sources: Industrial, Commercial and Institutional Boilers and Process Heaters.

In what form and how long must I keep my records?

(a) Your records must be in a form suitable and readily available for expeditious review, according to §63.10(b)(1).

(b) As specified in §63.10(b)(1), you must keep each record for 5 years following the date of each occurrence, measurement, maintenance, corrective action, report, or record.

(c) You must keep each record on site, or they must be accessible from on site (for example, through a computer network), for at least 2 years after the date of each occurrence, measurement, maintenance, corrective action, report, or record, according to §63.10(b)(1). You can keep the records off site for the remaining 3 years.

V. REPORTING REQUIREMENTS.

011 [25 Pa. Code §127.511]

Monitoring and related recordkeeping and reporting requirements.

At a minimum, the Owner/Operator shall verify SO₂ emission rates using the most recent AP-42 emission factors along with fuel usage records or with other applicable methods with prior written approval from the Department.

012 [25 Pa. Code §127.511]

Monitoring and related recordkeeping and reporting requirements.

At a minimum, the Owner/Operator shall verify particulate matter emission rates using the most recent AP-42 emission

**SECTION D. Source Level Requirements**

factors along with fuel usage records or with other applicable methods with prior written approval from the Department.

013 [40 CFR Part 60 Standards of Performance for New Stationary Sources §40 CFR 60.4]**Subpart A - General Provisions****Address.**

(a) All requests, reports, applications, submittals, and other communications to the Administrator pursuant to this part shall be submitted in duplicate to the appropriate Regional Office of the U.S. Environmental Protection Agency to the attention of the Director of the Division indicated in the following list of EPA Regional Offices.

Region III Director
Air Protection Division, Mail Code 3AP00,
1650 Arch Street,
Philadelphia, PA 19103-2029.

(b) Section 111(c) directs the Administrator to delegate to each State, when appropriate, the authority to implement and enforce standards of performance for new stationary sources located in such State. All information required to be submitted to EPA under paragraph (a) of this section, must also be submitted to the appropriate State Agency of any State to which this authority has been delegated (provided, that each specific delegation may except sources from a certain Federal or State reporting requirement). The appropriate mailing address for those States whose delegation request has been approved is as follows:

Pennsylvania DEP - Air Quality
400 Waterfront Drive
Pittsburgh, PA 15222

014 [40 CFR Part 60 Standards of Performance for New Stationary Sources §40 CFR 60.48c]**Subpart Dc - Standards of Performance for Small Industrial- Commercial-Institutional Steam Generating Units Reporting and recordkeeping requirements.**

(a)-(c) Not applicable.

(d) The owner or operator of each affected facility subject to the SO₂ emission limits, fuel oil sulfur limits, or percent reduction requirements under §60.42c shall submit reports to the Administrator.

(e) The owner or operator of each affected facility subject to the SO₂ emission limits, fuel oil sulfur limits, or percent reduction requirements under §60.42c shall keep records and submit reports as required under paragraph (d) of this section, including the following information, as applicable.

(1) Calendar dates covered in the reporting period.

(2) Each 30-day average SO₂ emission rate (ng/J or lb/MMBtu), or 30-day average sulfur content (weight percent), calculated during the reporting period, ending with the last 30-day period; reasons for any noncompliance with the emission standards; and a description of corrective actions taken.

(3)-(10) Not applicable.

(11) If fuel supplier certification is used to demonstrate compliance, records of fuel supplier certification as described under paragraph (f)(1), (2), (3), or (4) of this section, as applicable. In addition to records of fuel supplier certifications, the report shall include a certified statement signed by the owner or operator of the affected facility that the records of fuel supplier certifications submitted represent all of the fuel combusted during the reporting period.

(f) Fuel supplier certification shall include the following information:

(1) For distillate oil:

(i) The name of the oil supplier;

(ii) A statement from the oil supplier that the oil complies with the specifications under the definition of distillate oil in §60.41c; and

(iii) The sulfur content or maximum sulfur content of the oil.

**SECTION D. Source Level Requirements**

(2)-(4) Not applicable.

(g)-(h) Not applicable.

(i) All records required under this section shall be maintained by the owner or operator of the affected facility for a period of two years following the date of such record.

(j) The reporting period for the reports required under this subpart is each six-month period. All reports shall be submitted to the Administrator and shall be postmarked by the 30th day following the end of the reporting period.

015 [40 CFR Part 63 NESHAPS for Source Categories §40 CFR 63.7495]

Subpart DDDDD - National Emission Standards for Hazardous Air Pollutants for Major Sources: Industrial, Commercial and Institutional Boilers and Process Heaters.

When do I have to comply with this subpart?

(a) Not applicable.

(b) If you have an existing boiler or process heater, you must comply with this subpart no later than January 31, 2016, except as provided in §63.6(i).

(c) Not applicable.

(d) You must meet the notification requirements in §63.7545 according to the schedule in §63.7545 and in subpart A of this part. Some of the notifications must be submitted before you are required to comply with the emission limits and work practice standards in this subpart.

016 [40 CFR Part 63 NESHAPS for Source Categories §40 CFR 63.7545]

Subpart DDDDD - National Emission Standards for Hazardous Air Pollutants for Major Sources: Industrial, Commercial and Institutional Boilers and Process Heaters.

What notifications must I submit and when?

(a) You must submit to the Administrator all of the notifications in §§63.7(b) and (c), 63.8(e), (f)(4) and (6), and 63.9(b) through (h) that apply to you by the dates specified.

(b) As specified in §63.9(b)(2), if you startup your affected source before January 31, 2013, you must submit an Initial Notification not later than 120 days after January 31, 2013.

(c) - (h) Not applicable.

VI. WORK PRACTICE REQUIREMENTS.

017 [25 Pa. Code §129.97]

Presumptive RACT requirements, RACT emission limitations and petition for alternative compliance schedule.

(a) The owner and operator of a source listed in one or more of subsections (b)—(h) located at a major VOC emitting facility subject to §129.96 (relating to applicability) shall comply with the applicable presumptive RACT requirement or RACT emission limitation, or both, beginning with the specified compliance date as follows, unless an alternative compliance schedule is submitted and approved under subsections (k)—(m) or § 129.99 (relating to alternative RACT proposal and petition for alternative compliance schedule):

(1) January 1, 2017, for a source subject to §129.96(a).

(2) January 1, 2017, or 1 year after the date the source meets the definition of a major NOx emitting facility or major VOC emitting facility, whichever is later, for a source subject to §129.96(b).

(b) The owner and operator of a source specified in this subsection, which is located at a major VOC emitting facility subject to §129.96 shall comply with the following:

**SECTION D. Source Level Requirements**

(1) The presumptive RACT requirement for a combustion unit with a rated heat input equal to or greater than 20 million Btu/hour and less than 50 million Btu/hour, which is the performance of a biennial tune-up conducted in accordance with the procedures in 40 CFR 63.11223 (relating to how do I demonstrate continuous compliance with the work practice and management practice standards). The biennial tune-up must include, at a minimum, the following:

(i) Inspection and cleaning or replacement of fuel-burning equipment, including the burners and components, as necessary, for proper operation as specified by the manufacturer.

(ii) Inspection of the flame pattern and adjustment of the burner, as necessary, to optimize the flame pattern to minimize total emissions of NO_x and, to the extent possible, emissions of CO.

(iii) Inspection and adjustment, as necessary, of the air-to-fuel ratio control system to ensure proper calibration and operation as specified by the manufacturer.

(2) The owner or operator of a combustion unit with an oxygen trim system that maintains an optimum air-to-fuel ratio that would otherwise be subject to a biennial tune-up shall conduct a tune-up of the boiler one time in each 5-year calendar period. The tune-up must include, at a minimum, the following:

(i) Inspection and cleaning or replacement of fuel-burning equipment, including the burners and components, as necessary, for proper operation as specified by the manufacturer.

(ii) Inspection of the flame pattern and adjustment of the burner, as necessary, to optimize the flame pattern to minimize total emissions of NO_x and, to the extent possible, emissions of CO.

(iii) Inspection and adjustment, as necessary, of the air-to-fuel ratio control system to ensure proper calibration and operation as specified by the manufacturer.

(3) The applicable recordkeeping requirements of §129.100(d), (e) or (f) (relating to compliance demonstration and recordkeeping requirements).

018 [40 CFR Part 63 NESHAPS for Source Categories §40 CFR 63 Subpart DDDDD Table 3]

Subpart DDDDD - National Emission Standards for Hazardous Air Pollutants for Major Sources: Industrial, Commercial and Institutional Boilers and Process Heaters.

Work Practice Standards

As stated in §63.7500, you must comply with the following applicable work practice standards:

If your unit is . . .

1. A new or existing boiler or process heater with a continuous oxygen trim system that maintains an optimum air to fuel ratio, or a heat input capacity of less than or equal to 5 million Btu per hour in any of the following subcategories: unit designed to burn gas 1; unit designed to burn gas 2 (other); or unit designed to burn light liquid, or a limited use boiler or process heater

You must meet the following . . .

Conduct a tune-up of the boiler or process heater annually as specified in §63.7540.

019 [40 CFR Part 63 NESHAPS for Source Categories §40 CFR 63 Subpart DDDDD Table 3]

Subpart DDDDD - National Emission Standards for Hazardous Air Pollutants for Major Sources: Industrial, Commercial and Institutional Boilers and Process Heaters.

Work Practice Standards

As stated in §63.7500, you must comply with the following applicable work practice standards:

If your unit is . . .

**SECTION D. Source Level Requirements**

4. An existing boiler or process heater located at a major source facility, not including limited use units.

You must meet the following . . .

Must have a one-time energy assessment performed by a qualified energy assessor. An energy assessment completed on or after January 1, 2008, that meets or is amended to meet the energy assessment requirements in this table, satisfies the energy assessment requirement. A facility that operated under an energy management program developed according to the ENERGY STAR guidelines for energy management or compatible with ISO 50001 for at least one year between January 1, 2008 and the compliance date specified in §63.7495 that includes the affected units also satisfies the energy assessment requirement. The energy assessment must include the following with extent of the evaluation for items a. to e. appropriate for the on-site technical hours listed in §63.7575:

- a. A visual inspection of the boiler or process heater system.
- b. An evaluation of operating characteristics of the boiler or process heater systems, specifications of energy using systems, operating and maintenance procedures, and unusual operating constraints.
- c. An inventory of major energy use systems consuming energy from affected boilers and process heaters and which are under the control of the boiler/process heater owner/operator.
- d. A review of available architectural and engineering plans, facility operation and maintenance procedures and logs, and fuel usage.
- e. A review of the facility's energy management program and provide recommendations for improvements consistent with the definition of energy management program, if identified.
- f. A list of cost-effective energy conservation measures that are within the facility's control.
- g. A list of the energy savings potential of the energy conservation measures identified.
- h. A comprehensive report detailing the ways to improve efficiency, the cost of specific improvements, benefits, and the time frame for recouping those investments.

020 [40 CFR Part 63 NESHAPS for Source Categories §40 CFR 63.7500]

Subpart DDDDD - National Emission Standards for Hazardous Air Pollutants for Major Sources: Industrial, Commercial and Institutional Boilers and Process Heaters.

What emission limits, work practice standards, and operating limits must I meet?

(a) You must meet the requirements in paragraphs (a)(1) through (3) of this section, except as provided in paragraphs (b), through (e) of this section. You must meet these requirements at all times the affected unit is operating, except as provided in paragraph (f) of this section.

(1) - (2) Not applicable.

(3) At all times, you must operate and maintain any affected source (as defined in §63.7490), including associated air pollution control equipment and monitoring equipment, in a manner consistent with safety and good air pollution control practices for minimizing emissions. Determination of whether such operation and maintenance procedures are being used will be based on information available to the Administrator that may include, but is not limited to, monitoring results, review of operation and maintenance procedures, review of operation and maintenance records, and inspection of the source.

(b) - (d) Not applicable.

(e) Boilers and process heaters in the units designed to burn gas 1 fuels subcategory with a heat input capacity of less than or equal to 5 million Btu per hour must complete a tune-up every 5 years as specified in §63.7540. Boilers and process heaters in the units designed to burn gas 1 fuels subcategory with a heat input capacity greater than 5 million Btu per hour and less than 10 million Btu per hour must complete a tune-up every 2 years as specified in §63.7540. Boilers and process heaters in the units designed to burn gas 1 fuels subcategory are not subject to the emission limits in Tables 1 and 2 or 11 through 13 to this subpart, or the operating limits in Table 4 to this subpart.

(f) These standards apply at all times the affected unit is operating, except during periods of startup and shutdown during which time you must comply only with items 5 and 6 of Table 3 to this subpart.

**SECTION D. Source Level Requirements****# 021 [40 CFR Part 63 NESHAPS for Source Categories §40 CFR 63.7540]****Subpart DDDDD - National Emission Standards for Hazardous Air Pollutants for Major Sources: Industrial, Commercial and Institutional Boilers and Process Heaters.****How do I demonstrate continuous compliance with the emission limitations, fuel specifications and work practice standards?**

(a) You must demonstrate continuous compliance with each emission limit in Tables 1 and 2 or 11 through 13 to this subpart, the work practice standards in Table 3 to this subpart, and the operating limits in Table 4 to this subpart that applies to you according to the methods specified in Table 8 to this subpart and paragraphs (a)(1) through (19) of this section.

(1) - (11) Not applicable.

(12) If your boiler or process heater has a continuous oxygen trim system that maintains an optimum air to fuel ratio, or a heat input capacity of less than or equal to 5 million Btu per hour and the unit is in the units designed to burn gas 1; units designed to burn gas 2 (other); or units designed to burn light liquid subcategories, or meets the definition of limited-use boiler or process heater in §63.7575, you must conduct a tune-up of the boiler or process heater every 5 years as specified in paragraphs (a)(10)(i) through (vi) of this section to demonstrate continuous compliance. You may delay the burner inspection specified in paragraph (a)(10)(i) of this section until the next scheduled or unscheduled unit shutdown, but you must inspect each burner at least once every 72 months. If an oxygen trim system is utilized on a unit without emission standards to reduce the tune-up frequency to once every 5 years, set the oxygen level no lower than the oxygen concentration measured during the most recent tune-up.

(13) If the unit is not operating on the required date for a tune-up, the tune-up must be conducted within 30 calendar days of startup.

(14) - (19) Not applicable.

VII. ADDITIONAL REQUIREMENTS.**# 022 [40 CFR Part 60 Standards of Performance for New Stationary Sources §40 CFR 60.10]****Subpart A - General Provisions****State authority.**

The provisions of this part shall not be construed in any manner to preclude any State or political subdivision thereof from:

(a) Adopting and enforcing any emission standard or limitation applicable to an affected facility, provided that such emission standard or limitation is not less stringent than the standard applicable to such facility.

(b) Requiring the owner or operator of an affected facility to obtain permits, licenses, or approvals prior to initiating construction, modification, or operation of such facility.

023 [40 CFR Part 60 Standards of Performance for New Stationary Sources §40 CFR 60.12]**Subpart A - General Provisions****Circumvention.**

No owner or operator subject to the provisions of this part shall build, erect, install, or use any article, machine, equipment or process, the use of which conceals an emission which would otherwise constitute a violation of an applicable standard. Such concealment includes, but is not limited to, the use of gaseous diluents to achieve compliance with an opacity standard or with a standard which is based on the concentration of a pollutant in the gases discharged to the atmosphere.

024 [40 CFR Part 60 Standards of Performance for New Stationary Sources §40 CFR 60.42c]**Subpart Dc - Standards of Performance for Small Industrial- Commercial-Institutional Steam Generating Units
Standard for sulfur dioxide.**

In accordance with 40 CFR 60.42c(h), compliance with the emission limits or fuel oil sulfur limits under this section may be determined based on a certification from the fuel supplier.

**SECTION D. Source Level Requirements****# 025 [40 CFR Part 60 Standards of Performance for New Stationary Sources §40 CFR 60.5]****Subpart A - General Provisions****Determination of construction or modification.**

(a) When requested to do so by an owner or operator, the Administrator will make a determination of whether action taken or intended to be taken by such owner or operator constitutes construction (including reconstruction) or modification or the commencement thereof within the meaning of this part.

(b) The Administrator will respond to any request for a determination under paragraph (a) of this section within 30 days of receipt of such request.

026 [40 CFR Part 60 Standards of Performance for New Stationary Sources §40 CFR 60.6]**Subpart A - General Provisions****Review of plans.**

(a) When requested to do so by an owner or operator, the Administrator will review plans for construction or modification for the purpose of providing technical advice to the owner or operator.

(b)(1) A separate request shall be submitted for each construction or modification project.

(2) Each request shall identify the location of such project, and be accompanied by technical information describing the proposed nature, size, design, and method of operation of each affected facility involved in such project, including information on any equipment to be used for measurement or control of emissions.

(c) Neither a request for plans review nor advice furnished by the Administrator in response to such request shall (1) relieve an owner or operator of legal responsibility for compliance with any provision of this part or of any applicable State or local requirement, or (2) prevent the Administrator from implementing or enforcing any provision of this part or taking any other action authorized by the Act.

027 [40 CFR Part 60 Standards of Performance for New Stationary Sources §40 CFR 60.9]**Subpart A - General Provisions****Availability of information.**

The availability to the public of information provided to, or otherwise obtained by, the Administrator under this part shall be governed by part 2 of this chapter. [Information submitted voluntarily to the Administrator for the purposes of 60.5 and 60.6 is governed by 2.201 through 2.213 of this chapter and not by 2.301 of this chapter.]

028 [40 CFR Part 63 NESHAPS for Source Categories §40 CFR 63.7485]**Subpart DDDDD - National Emission Standards for Hazardous Air Pollutants for Major Sources: Industrial, Commercial and Institutional Boilers and Process Heaters.****Am I subject to this subpart?**

You are subject to this subpart if you own or operate an industrial, commercial, or institutional boiler or process heater as defined in §63.7575 that is located at, or is part of, a major source of HAP, except as specified in §63.7491. For purposes of this subpart, a major source of HAP is as defined in §63.2, except that for oil and natural gas production facilities, a major source of HAP is as defined in §63.7575.

029 [40 CFR Part 63 NESHAPS for Source Categories §40 CFR 63.7490]**Subpart DDDDD - National Emission Standards for Hazardous Air Pollutants for Major Sources: Industrial, Commercial and Institutional Boilers and Process Heaters.****What is the affected source of this subpart?**

(a) This subpart applies to new, reconstructed, and existing affected sources as described in paragraphs (a)(1) and (2) of this section.

(1) The affected source of this subpart is the collection at a major source of all existing industrial, commercial, and institutional boilers and process heaters within a subcategory as defined in §63.7575.

(2) The affected source of this subpart is each new or reconstructed industrial, commercial, or institutional boiler or process

**SECTION D. Source Level Requirements**

heater, as defined in §63.7575, located at a major source.

- (b) Not applicable.
- (c) Not applicable.
- (d) A boiler or process heater is existing if it is not new or reconstructed.
- (e) Not applicable.

030 [40 CFR Part 63 NESHAPS for Source Categories §40 CFR 63.7499]

Subpart DDDDD - National Emission Standards for Hazardous Air Pollutants for Major Sources: Industrial, Commercial and Institutional Boilers and Process Heaters.

What are the subcategories of boilers and process heaters?

The subcategories of boilers and process heaters, as defined in §63.7575 are:

- (l) Units designed to burn gas 1 fuels.

***** Permit Shield in Effect. *****

**SECTION D. Source Level Requirements**

Source ID: 035

Source Name: BOILER #2

Source Capacity/Throughput:	25.100	MMBTU/HR	
	24.100	MCF/HR	Natural Gas
	178.000	Gal/HR	#2 Oil

Conditions for this source occur in the following groups: G02

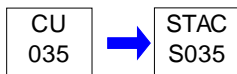
**I. RESTRICTIONS.****Emission Restriction(s).****# 001 [25 Pa. Code §123.11]****Combustion units**

(a) A person may not permit the emission into the outdoor atmosphere of particulate matter from a combustion unit in excess of the following:

(1) The rate of 0.4 pound per million Btu of heat input, when the heat input to the combustion unit in millions of Btus per hour is greater than 2.5 but less than 50.

(2)-(3) Not applicable.

(b) Not applicable.

002 [25 Pa. Code §123.22]**Combustion units**

(a)-(c) Not applicable.

(d) Allegheny County, Lower Beaver Valley, and Monongahela Valley air basins. Combustion units in these subject air basins must conform with the following:

(1) General provision. A person may not permit the emission into the outdoor atmosphere of sulfur oxides, expressed as SO₂, from a combustion unit in excess of one or more of the following:

(i) The rate of 1 pound per million Btu of heat input, when the heat input to the combustion unit in millions of Btus per hour is greater than 2.5 but less than 50.

(ii)-(iii) Not applicable.

(2) Commercial fuel oil.

(i) Except as specified in subparagraphs (ii) and (iii), a person may not offer for sale, deliver for use, exchange in trade or permit the use of commercial fuel oil in the subject air basins on or after July 1, 2016, if the commercial fuel oil contains sulfur in excess of the applicable maximum allowable sulfur content set forth in the following table:

Maximum Allowable Sulfur Content Beginning July 1, 2016,
Expressed as Parts per Million (ppm) by Weight or Percentage by Weight

Grades Commercial Fuel Oil (Consistent with ASTM D396)

No. 2 and lighter oil 500 ppm (0.05%)

No. 4 oil 2,500 ppm (0.25%)

No. 5, No. 6 and heavier oil 5,000 ppm (0.5%)

**SECTION D. Source Level Requirements**

(ii) Commercial fuel oil that was stored in this Commonwealth by the ultimate consumer prior to July 1, 2016, which met the applicable maximum allowable sulfur content at the time it was stored, may be used by the ultimate consumer in this Commonwealth on and after July 1, 2016.

(iii) Beginning July 1, 2016, the Department may temporarily suspend or increase the applicable maximum allowable sulfur content for a commercial fuel oil set forth in subparagraph (i) if the following occur:

(A) The Department receives a written request at the address specified in subsection (h) for a suspension or increase on the basis that compliant commercial fuel oil is not reasonably available in a subject air basin. The request must include the following:

(I) The subject air basin for which the suspension or increase is requested.

(II) The reason compliant commercial fuel oil is not reasonably available.

(III) The duration of time for which the suspension or increase is requested and the justification for the requested duration.

(B) The Department determines that an insufficient quantity of compliant commercial fuel oil is reasonably available in the air basin and that the circumstances leading to the insufficiency are due to events that could not have been reasonably foreseen or prevented and are not due to lack of prudent planning on the part of the transferor of the commercial fuel oil into or within the air basin.

(C) The Department approves the request, in writing, prior to the transferor distributing the noncompliant commercial fuel oil into or within the air basin.

(iv) The Department will limit a suspension or increase in the applicable maximum allowable sulfur content granted under subparagraph (iii) to the shortest duration in which adequate supplies of compliant commercial fuel oil can be made reasonably available, but in no case longer than 60 days from the date the Department grants the suspension or increase.

(3) Equivalency provision. Paragraph (2) does not apply to a person who uses equipment or a process, or to the owner or operator of an installation where equipment or a process is used, to reduce the sulfur emissions from the burning of a fuel with a higher sulfur content than that specified in paragraph (2). The emissions may not exceed those which would result from the use of commercial fuel oil that meets the applicable maximum allowable sulfur content specified in paragraph (2).

(e) Not applicable.

**# 003 [40 CFR Part 60 Standards of Performance for New Stationary Sources §40 CFR 60.42c]
Subpart Dc - Standards of Performance for Small Industrial- Commercial-Institutional Steam Generating Units
Standard for sulfur dioxide.**

(a)-(c) Not applicable.

(d) On and after the date on which the initial performance test is completed or required to be completed under §60.8, whichever date comes first, no owner or operator of an affected facility that combusts oil shall cause to be discharged into the atmosphere from that affected facility any gases that contain SO₂ in excess of 215 ng/J (0.50 lb/MMBtu) heat input from oil; or, as an alternative, no owner or operator of an affected facility that combusts oil shall combust oil in the affected facility that contains greater than 0.5 weight percent sulfur. The percent reduction requirements are not applicable to affected facilities under this paragraph.

(e)-(f) Not applicable.

(h) For affected facilities listed under paragraphs (h)(1), (2), (3), or (4) of this section, compliance with the emission limits or fuel oil sulfur limits under this section may be determined based on a certification from the fuel supplier, as described under §60.48c(f), as applicable.

(1) Distillate oil-fired affected facilities with heat input capacities between 2.9 and 29 MW (10 and 100 MMBtu/hr).

(2)-(4) Not applicable.

**SECTION D. Source Level Requirements**

(i) The SO₂ emission limits, fuel oil sulfur limits, and percent reduction requirements under this section apply at all times, including periods of startup, shutdown, and malfunction.

(j) Not applicable.

II. TESTING REQUIREMENTS.

No additional testing requirements exist except as provided in other sections of this permit including Section B (Title V General Requirements) and/or Section E (Source Group Restrictions).

III. MONITORING REQUIREMENTS.

No additional monitoring requirements exist except as provided in other sections of this permit including Section B (Title V General Requirements) and/or Section E (Source Group Restrictions).

IV. RECORDKEEPING REQUIREMENTS.**# 004 [25 Pa. Code §127.511]****Monitoring and related recordkeeping and reporting requirements.**

The Owner/Operator shall maintain records of natural gas and fuel oil usage on a monthly basis for the above boilers for the purpose of determining compliance with the applicable emission restrictions within this operating permit.

005 [25 Pa. Code §127.511]**Monitoring and related recordkeeping and reporting requirements.**

The Owner/Operator shall maintain records containing at a minimum, a Certification of sulfur content in the fuel oil used from the supplier and a Certification of sulfur content in the natural gas utilized in these boilers.

006 [25 Pa. Code §129.100]**Compliance demonstration and recordkeeping requirements.**

(a) - (c) Not applicable.

(d) The owner and operator of an air contamination source subject to this section and §§ 129.96—129.99 shall keep records to demonstrate compliance with §§ 129.96—129.99 in the following manner:

(1) The records must include sufficient data and calculations to demonstrate that the requirements of §§ 129.96—129.99 are met.

(2) Data or information required to determine compliance shall be recorded and maintained in a time frame consistent with the averaging period of the requirement.

(e) Not applicable.

(f) Not applicable.

(g) The owner or operator of a combustion unit subject to § 129.97(b) shall record each adjustment conducted under the procedures in § 129.97(b). This record must contain, at a minimum:

(1) The date of the tuning procedure.

(2) The name of the service company and the technician performing the procedure.

(3) The final operating rate or load.

**SECTION D. Source Level Requirements**

- (4) The final NO_x and CO emission rates.
- (5) The final excess oxygen rate.
- (6) Other information required by the applicable operating permit.
- (h) Not applicable.
- (i) The records shall be retained by the owner or operator for 5 years and made available to the Department or appropriate approved local air pollution control agency upon receipt of a written request from the Department or appropriate approved local air pollution agency.

**# 007 [40 CFR Part 60 Standards of Performance for New Stationary Sources §40 CFR 60.48c]
Subpart Dc - Standards of Performance for Small Industrial- Commercial-Institutional Steam Generating Units
Reporting and recordkeeping requirements.**

In accordance with 40 CFR 60.48c (e), the permittee shall maintain records of fuel supplier certification to include the following information;

- (i) the name of the oil supplier
- (ii) a statement from the supplier that the oil complies with the specifications for fuel oil numbers 1 or 2, as defined in ASTM D396-78.

**# 008 [40 CFR Part 60 Standards of Performance for New Stationary Sources §40 CFR 60.7]
Subpart A - General Provisions
Notification and record keeping.**

(a) Any owner or operator subject to the provisions of this part shall furnish the Administrator written notification as follows:

(1)-(3) Not applicable.

(4) A notification of any physical or operational change to an existing facility which may increase the emission rate of any air pollutant to which a standard applies, unless that change is specifically exempted under an applicable subpart or in 60.14(e). This notice shall be postmarked 60 days or as soon as practicable before the change is commenced and shall include information describing the precise nature of the change, present and proposed emission control systems, productive capacity of the facility before and after the change, and the expected completion date of the change. The Administrator may request additional relevant information subsequent to this notice.

(5)-(7) Not applicable.

(b) Any owner or operator subject to the provisions of this part shall maintain records of the occurrence and duration of any startup, shutdown, or malfunction in the operation of an affected facility; any malfunction of the air pollution control equipment; or any periods during which a continuous monitoring system or monitoring device is inoperative.

(c)-(d) Not applicable.

(e)(1) Not applicable

(2) The frequency of reporting of excess emissions and monitoring systems performance (and summary) reports may be reduced only after the owner or operator notifies the Administrator in writing of his or her intention to make such a change and the Administrator does not object to the intended change. In deciding whether to approve a reduced frequency of reporting, the Administrator may review information concerning the source's entire previous performance history during the required recordkeeping period prior to the intended change, including performance test results, monitoring data, and evaluations of an owner or operator's conformance with operation and maintenance requirements. Such information may be used by the Administrator to make a judgment about the source's potential for noncompliance in the future. If the Administrator disapproves the owner or operator's request to reduce the frequency of reporting, the Administrator will notify

**SECTION D. Source Level Requirements**

the owner or operator in writing within 45 days after receiving notice of the owner or operator's intention. The notification from the Administrator to the owner or operator will specify the grounds on which the disapproval is based. In the absence of a notice of disapproval within 45 days, approval is automatically granted.

(3) Not applicable.

(f) Not applicable.

(g) If notification substantially similar to that in paragraph (a) of this section is required by any other State or local agency, sending the Administrator a copy of that notification will satisfy the requirements of paragraph (a) of this section.

(h) Individual subparts of this part may include specific provisions which clarify or make inapplicable the provisions set forth in this section.

009 [40 CFR Part 63 NESHAPS for Source Categories §40 CFR 63.7555]

Subpart DDDDD - National Emission Standards for Hazardous Air Pollutants for Major Sources: Industrial, Commercial and Institutional Boilers and Process Heaters.

What records must I keep?

(a) You must keep records according to paragraphs (a)(1) and (2) of this section.

(1) A copy of each notification and report that you submitted to comply with this subpart, including all documentation supporting any Initial Notification or Notification of Compliance Status or semiannual compliance report that you submitted, according to the requirements in §63.10(b)(2)(xiv).

(2) Records of performance tests, fuel analyses, or other compliance demonstrations and performance evaluations as required in §63.10(b)(2)(viii).

(3) Not applicable.

(b) - (h) Not applicable.

010 [40 CFR Part 63 NESHAPS for Source Categories §40 CFR 63.7560]

Subpart DDDDD - National Emission Standards for Hazardous Air Pollutants for Major Sources: Industrial, Commercial and Institutional Boilers and Process Heaters.

In what form and how long must I keep my records?

(a) Your records must be in a form suitable and readily available for expeditious review, according to §63.10(b)(1).

(b) As specified in §63.10(b)(1), you must keep each record for 5 years following the date of each occurrence, measurement, maintenance, corrective action, report, or record.

(c) You must keep each record on site, or they must be accessible from on site (for example, through a computer network), for at least 2 years after the date of each occurrence, measurement, maintenance, corrective action, report, or record, according to §63.10(b)(1). You can keep the records off site for the remaining 3 years.

V. REPORTING REQUIREMENTS.

011 [25 Pa. Code §127.511]

Monitoring and related recordkeeping and reporting requirements.

At a minimum, the Owner/Operator shall verify SO₂ emission rates using the most recent AP-42 emission factors along with fuel usage records or with other applicable methods with prior written approval from the Department.

012 [25 Pa. Code §127.511]

Monitoring and related recordkeeping and reporting requirements.

At a minimum, the Owner/Operator shall verify particulate matter emission rates using the most recent AP-42 emission

**SECTION D. Source Level Requirements**

factors along with fuel usage records or with other applicable methods with prior written approval from the Department.

013 [40 CFR Part 60 Standards of Performance for New Stationary Sources §40 CFR 60.4]**Subpart A - General Provisions****Address.**

(a) All requests, reports, applications, submittals, and other communications to the Administrator pursuant to this part shall be submitted in duplicate to the appropriate Regional Office of the U.S. Environmental Protection Agency to the attention of the Director of the Division indicated in the following list of EPA Regional Offices.

Region III Director
Air Protection Division, Mail Code 3AP00,
1650 Arch Street,
Philadelphia, PA 19103-2029.

(b) Section 111(c) directs the Administrator to delegate to each State, when appropriate, the authority to implement and enforce standards of performance for new stationary sources located in such State. All information required to be submitted to EPA under paragraph (a) of this section, must also be submitted to the appropriate State Agency of any State to which this authority has been delegated (provided, that each specific delegation may except sources from a certain Federal or State reporting requirement). The appropriate mailing address for those States whose delegation request has been approved is as follows:

Pennsylvania DEP - Air Quality
400 Waterfront Drive
Pittsburgh, PA 15222

014 [40 CFR Part 60 Standards of Performance for New Stationary Sources §40 CFR 60.48c]**Subpart Dc - Standards of Performance for Small Industrial- Commercial-Institutional Steam Generating Units Reporting and recordkeeping requirements.**

(a)-(c) Not applicable.

(d) The owner or operator of each affected facility subject to the SO₂ emission limits, fuel oil sulfur limits, or percent reduction requirements under §60.42c shall submit reports to the Administrator.

(e) The owner or operator of each affected facility subject to the SO₂ emission limits, fuel oil sulfur limits, or percent reduction requirements under §60.42c shall keep records and submit reports as required under paragraph (d) of this section, including the following information, as applicable.

(1) Calendar dates covered in the reporting period.

(2) Each 30-day average SO₂ emission rate (ng/J or lb/MMBtu), or 30-day average sulfur content (weight percent), calculated during the reporting period, ending with the last 30-day period; reasons for any noncompliance with the emission standards; and a description of corrective actions taken.

(3)-(10) Not applicable.

(11) If fuel supplier certification is used to demonstrate compliance, records of fuel supplier certification as described under paragraph (f)(1), (2), (3), or (4) of this section, as applicable. In addition to records of fuel supplier certifications, the report shall include a certified statement signed by the owner or operator of the affected facility that the records of fuel supplier certifications submitted represent all of the fuel combusted during the reporting period.

(f) Fuel supplier certification shall include the following information:

(1) For distillate oil:

(i) The name of the oil supplier;

(ii) A statement from the oil supplier that the oil complies with the specifications under the definition of distillate oil in §60.41c; and

(iii) The sulfur content or maximum sulfur content of the oil.

**SECTION D. Source Level Requirements**

(2)-(4) Not applicable.

(g)-(h) Not applicable.

(i) All records required under this section shall be maintained by the owner or operator of the affected facility for a period of two years following the date of such record.

(j) The reporting period for the reports required under this subpart is each six-month period. All reports shall be submitted to the Administrator and shall be postmarked by the 30th day following the end of the reporting period.

015 [40 CFR Part 63 NESHAPS for Source Categories §40 CFR 63.7495]

Subpart DDDDD - National Emission Standards for Hazardous Air Pollutants for Major Sources: Industrial, Commercial and Institutional Boilers and Process Heaters.

When do I have to comply with this subpart?

(a) Not applicable.

(b) If you have an existing boiler or process heater, you must comply with this subpart no later than January 31, 2016, except as provided in §63.6(i).

(c) Not applicable.

(d) You must meet the notification requirements in §63.7545 according to the schedule in §63.7545 and in subpart A of this part. Some of the notifications must be submitted before you are required to comply with the emission limits and work practice standards in this subpart.

016 [40 CFR Part 63 NESHAPS for Source Categories §40 CFR 63.7545]

Subpart DDDDD - National Emission Standards for Hazardous Air Pollutants for Major Sources: Industrial, Commercial and Institutional Boilers and Process Heaters.

What notifications must I submit and when?

(a) You must submit to the Administrator all of the notifications in §§63.7(b) and (c), 63.8(e), (f)(4) and (6), and 63.9(b) through (h) that apply to you by the dates specified.

(b) As specified in §63.9(b)(2), if you startup your affected source before January 31, 2013, you must submit an Initial Notification not later than 120 days after January 31, 2013.

(c) - (h) Not applicable.

VI. WORK PRACTICE REQUIREMENTS.

017 [25 Pa. Code §129.97]

Presumptive RACT requirements, RACT emission limitations and petition for alternative compliance schedule.

(a) The owner and operator of a source listed in one or more of subsections (b)—(h) located at a major VOC emitting facility subject to §129.96 (relating to applicability) shall comply with the applicable presumptive RACT requirement or RACT emission limitation, or both, beginning with the specified compliance date as follows, unless an alternative compliance schedule is submitted and approved under subsections (k)—(m) or § 129.99 (relating to alternative RACT proposal and petition for alternative compliance schedule):

(1) January 1, 2017, for a source subject to §129.96(a).

(2) January 1, 2017, or 1 year after the date the source meets the definition of a major NOx emitting facility or major VOC emitting facility, whichever is later, for a source subject to §129.96(b).

(b) The owner and operator of a source specified in this subsection, which is located at a major VOC emitting facility subject to §129.96 shall comply with the following:

**SECTION D. Source Level Requirements**

(1) The presumptive RACT requirement for a combustion unit with a rated heat input equal to or greater than 20 million Btu/hour and less than 50 million Btu/hour, which is the performance of a biennial tune-up conducted in accordance with the procedures in 40 CFR 63.11223 (relating to how do I demonstrate continuous compliance with the work practice and management practice standards). The biennial tune-up must include, at a minimum, the following:

(i) Inspection and cleaning or replacement of fuel-burning equipment, including the burners and components, as necessary, for proper operation as specified by the manufacturer.

(ii) Inspection of the flame pattern and adjustment of the burner, as necessary, to optimize the flame pattern to minimize total emissions of NO_x and, to the extent possible, emissions of CO.

(iii) Inspection and adjustment, as necessary, of the air-to-fuel ratio control system to ensure proper calibration and operation as specified by the manufacturer.

(2) The owner or operator of a combustion unit with an oxygen trim system that maintains an optimum air-to-fuel ratio that would otherwise be subject to a biennial tune-up shall conduct a tune-up of the boiler one time in each 5-year calendar period. The tune-up must include, at a minimum, the following:

(i) Inspection and cleaning or replacement of fuel-burning equipment, including the burners and components, as necessary, for proper operation as specified by the manufacturer.

(ii) Inspection of the flame pattern and adjustment of the burner, as necessary, to optimize the flame pattern to minimize total emissions of NO_x and, to the extent possible, emissions of CO.

(iii) Inspection and adjustment, as necessary, of the air-to-fuel ratio control system to ensure proper calibration and operation as specified by the manufacturer.

(3) The applicable recordkeeping requirements of §129.100(d), (e) or (f) (relating to compliance demonstration and recordkeeping requirements).

018 [40 CFR Part 63 NESHAPS for Source Categories §40 CFR 63 Subpart DDDDD Table 3]

Subpart DDDDD - National Emission Standards for Hazardous Air Pollutants for Major Sources: Industrial, Commercial and Institutional Boilers and Process Heaters.

Work Practice Standards

As stated in §63.7500, you must comply with the following applicable work practice standards:

If your unit is . . .

1. A new or existing boiler or process heater with a continuous oxygen trim system that maintains an optimum air to fuel ratio, or a heat input capacity of less than or equal to 5 million Btu per hour in any of the following subcategories: unit designed to burn gas 1; unit designed to burn gas 2 (other); or unit designed to burn light liquid, or a limited use boiler or process heater

You must meet the following . . .

Conduct a tune-up of the boiler or process heater annually as specified in §63.7540.

019 [40 CFR Part 63 NESHAPS for Source Categories §40 CFR 63 Subpart DDDDD Table 3]

Subpart DDDDD - National Emission Standards for Hazardous Air Pollutants for Major Sources: Industrial, Commercial and Institutional Boilers and Process Heaters.

Work Practice Standards

As stated in §63.7500, you must comply with the following applicable work practice standards:

If your unit is . . .

**SECTION D. Source Level Requirements**

4. An existing boiler or process heater located at a major source facility, not including limited use units.

You must meet the following . . .

Must have a one-time energy assessment performed by a qualified energy assessor. An energy assessment completed on or after January 1, 2008, that meets or is amended to meet the energy assessment requirements in this table, satisfies the energy assessment requirement. A facility that operated under an energy management program developed according to the ENERGY STAR guidelines for energy management or compatible with ISO 50001 for at least one year between January 1, 2008 and the compliance date specified in §63.7495 that includes the affected units also satisfies the energy assessment requirement. The energy assessment must include the following with extent of the evaluation for items a. to e. appropriate for the on-site technical hours listed in §63.7575:

- a. A visual inspection of the boiler or process heater system.
- b. An evaluation of operating characteristics of the boiler or process heater systems, specifications of energy using systems, operating and maintenance procedures, and unusual operating constraints.
- c. An inventory of major energy use systems consuming energy from affected boilers and process heaters and which are under the control of the boiler/process heater owner/operator.
- d. A review of available architectural and engineering plans, facility operation and maintenance procedures and logs, and fuel usage.
- e. A review of the facility's energy management program and provide recommendations for improvements consistent with the definition of energy management program, if identified.
- f. A list of cost-effective energy conservation measures that are within the facility's control.
- g. A list of the energy savings potential of the energy conservation measures identified.
- h. A comprehensive report detailing the ways to improve efficiency, the cost of specific improvements, benefits, and the time frame for recouping those investments.

020 [40 CFR Part 63 NESHAPS for Source Categories §40 CFR 63.7500]

Subpart DDDDD - National Emission Standards for Hazardous Air Pollutants for Major Sources: Industrial, Commercial and Institutional Boilers and Process Heaters.

What emission limits, work practice standards, and operating limits must I meet?

(a) You must meet the requirements in paragraphs (a)(1) through (3) of this section, except as provided in paragraphs (b), through (e) of this section. You must meet these requirements at all times the affected unit is operating, except as provided in paragraph (f) of this section.

(1) - (2) Not applicable.

(3) At all times, you must operate and maintain any affected source (as defined in §63.7490), including associated air pollution control equipment and monitoring equipment, in a manner consistent with safety and good air pollution control practices for minimizing emissions. Determination of whether such operation and maintenance procedures are being used will be based on information available to the Administrator that may include, but is not limited to, monitoring results, review of operation and maintenance procedures, review of operation and maintenance records, and inspection of the source.

(b) - (d) Not applicable.

(e) Boilers and process heaters in the units designed to burn gas 1 fuels subcategory with a heat input capacity of less than or equal to 5 million Btu per hour must complete a tune-up every 5 years as specified in §63.7540. Boilers and process heaters in the units designed to burn gas 1 fuels subcategory with a heat input capacity greater than 5 million Btu per hour and less than 10 million Btu per hour must complete a tune-up every 2 years as specified in §63.7540. Boilers and process heaters in the units designed to burn gas 1 fuels subcategory are not subject to the emission limits in Tables 1 and 2 or 11 through 13 to this subpart, or the operating limits in Table 4 to this subpart.

(f) These standards apply at all times the affected unit is operating, except during periods of startup and shutdown during which time you must comply only with items 5 and 6 of Table 3 to this subpart.

**SECTION D. Source Level Requirements****# 021 [40 CFR Part 63 NESHAPS for Source Categories §40 CFR 63.7540]****Subpart DDDDD - National Emission Standards for Hazardous Air Pollutants for Major Sources: Industrial, Commercial and Institutional Boilers and Process Heaters.****How do I demonstrate continuous compliance with the emission limitations, fuel specifications and work practice standards?**

(a) You must demonstrate continuous compliance with each emission limit in Tables 1 and 2 or 11 through 13 to this subpart, the work practice standards in Table 3 to this subpart, and the operating limits in Table 4 to this subpart that applies to you according to the methods specified in Table 8 to this subpart and paragraphs (a)(1) through (19) of this section.

(1) - (11) Not applicable.

(12) If your boiler or process heater has a continuous oxygen trim system that maintains an optimum air to fuel ratio, or a heat input capacity of less than or equal to 5 million Btu per hour and the unit is in the units designed to burn gas 1; units designed to burn gas 2 (other); or units designed to burn light liquid subcategories, or meets the definition of limited-use boiler or process heater in §63.7575, you must conduct a tune-up of the boiler or process heater every 5 years as specified in paragraphs (a)(10)(i) through (vi) of this section to demonstrate continuous compliance. You may delay the burner inspection specified in paragraph (a)(10)(i) of this section until the next scheduled or unscheduled unit shutdown, but you must inspect each burner at least once every 72 months. If an oxygen trim system is utilized on a unit without emission standards to reduce the tune-up frequency to once every 5 years, set the oxygen level no lower than the oxygen concentration measured during the most recent tune-up.

(13) If the unit is not operating on the required date for a tune-up, the tune-up must be conducted within 30 calendar days of startup.

(14) - (19) Not applicable.

VII. ADDITIONAL REQUIREMENTS.**# 022 [40 CFR Part 60 Standards of Performance for New Stationary Sources §40 CFR 60.10]****Subpart A - General Provisions****State authority.**

The provisions of this part shall not be construed in any manner to preclude any State or political subdivision thereof from:

(a) Adopting and enforcing any emission standard or limitation applicable to an affected facility, provided that such emission standard or limitation is not less stringent than the standard applicable to such facility.

(b) Requiring the owner or operator of an affected facility to obtain permits, licenses, or approvals prior to initiating construction, modification, or operation of such facility.

023 [40 CFR Part 60 Standards of Performance for New Stationary Sources §40 CFR 60.12]**Subpart A - General Provisions****Circumvention.**

No owner or operator subject to the provisions of this part shall build, erect, install, or use any article, machine, equipment or process, the use of which conceals an emission which would otherwise constitute a violation of an applicable standard. Such concealment includes, but is not limited to, the use of gaseous diluents to achieve compliance with an opacity standard or with a standard which is based on the concentration of a pollutant in the gases discharged to the atmosphere.

024 [40 CFR Part 60 Standards of Performance for New Stationary Sources §40 CFR 60.42c]**Subpart Dc - Standards of Performance for Small Industrial- Commercial-Institutional Steam Generating Units
Standard for sulfur dioxide.**

In accordance with 40 CFR 60.42c(h), compliance with the emission limits or fuel oil sulfur limits under this section may be determined based on a certification from the fuel supplier.

**SECTION D. Source Level Requirements****# 025 [40 CFR Part 60 Standards of Performance for New Stationary Sources §40 CFR 60.5]****Subpart A - General Provisions****Determination of construction or modification.**

(a) When requested to do so by an owner or operator, the Administrator will make a determination of whether action taken or intended to be taken by such owner or operator constitutes construction (including reconstruction) or modification or the commencement thereof within the meaning of this part.

(b) The Administrator will respond to any request for a determination under paragraph (a) of this section within 30 days of receipt of such request.

026 [40 CFR Part 60 Standards of Performance for New Stationary Sources §40 CFR 60.6]**Subpart A - General Provisions****Review of plans.**

(a) When requested to do so by an owner or operator, the Administrator will review plans for construction or modification for the purpose of providing technical advice to the owner or operator.

(b)(1) A separate request shall be submitted for each construction or modification project.

(2) Each request shall identify the location of such project, and be accompanied by technical information describing the proposed nature, size, design, and method of operation of each affected facility involved in such project, including information on any equipment to be used for measurement or control of emissions.

(c) Neither a request for plans review nor advice furnished by the Administrator in response to such request shall (1) relieve an owner or operator of legal responsibility for compliance with any provision of this part or of any applicable State or local requirement, or (2) prevent the Administrator from implementing or enforcing any provision of this part or taking any other action authorized by the Act.

027 [40 CFR Part 60 Standards of Performance for New Stationary Sources §40 CFR 60.9]**Subpart A - General Provisions****Availability of information.**

The availability to the public of information provided to, or otherwise obtained by, the Administrator under this part shall be governed by part 2 of this chapter. [Information submitted voluntarily to the Administrator for the purposes of 60.5 and 60.6 is governed by 2.201 through 2.213 of this chapter and not by 2.301 of this chapter.]

028 [40 CFR Part 63 NESHAPS for Source Categories §40 CFR 63.7485]**Subpart DDDDD - National Emission Standards for Hazardous Air Pollutants for Major Sources: Industrial, Commercial and Institutional Boilers and Process Heaters.****Am I subject to this subpart?**

You are subject to this subpart if you own or operate an industrial, commercial, or institutional boiler or process heater as defined in §63.7575 that is located at, or is part of, a major source of HAP, except as specified in §63.7491. For purposes of this subpart, a major source of HAP is as defined in §63.2, except that for oil and natural gas production facilities, a major source of HAP is as defined in §63.7575.

029 [40 CFR Part 63 NESHAPS for Source Categories §40 CFR 63.7490]**Subpart DDDDD - National Emission Standards for Hazardous Air Pollutants for Major Sources: Industrial, Commercial and Institutional Boilers and Process Heaters.****What is the affected source of this subpart?**

(a) This subpart applies to new, reconstructed, and existing affected sources as described in paragraphs (a)(1) and (2) of this section.

(1) The affected source of this subpart is the collection at a major source of all existing industrial, commercial, and institutional boilers and process heaters within a subcategory as defined in §63.7575.

(2) The affected source of this subpart is each new or reconstructed industrial, commercial, or institutional boiler or process

**SECTION D. Source Level Requirements**

heater, as defined in §63.7575, located at a major source.

- (b) Not applicable.
- (c) Not applicable.
- (d) A boiler or process heater is existing if it is not new or reconstructed.
- (e) Not applicable.

030 [40 CFR Part 63 NESHAPS for Source Categories §40 CFR 63.7499]

Subpart DDDDD - National Emission Standards for Hazardous Air Pollutants for Major Sources: Industrial, Commercial and Institutional Boilers and Process Heaters.

What are the subcategories of boilers and process heaters?

The subcategories of boilers and process heaters, as defined in §63.7575 are:

- (l) Units designed to burn gas 1 fuels.

***** Permit Shield in Effect. *****

**SECTION D. Source Level Requirements**

Source ID: 103

Source Name: VAPORIZER

Source Capacity/Throughput:	12.500	MMBTU/HR	
	88.700	Gal/HR	#2 Oil
	12.000	MCF/HR	Natural Gas

Conditions for this source occur in the following groups: G01
G02

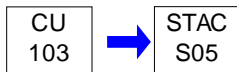
**I. RESTRICTIONS.****Emission Restriction(s).****# 001 [25 Pa. Code §123.11]****Combustion units**

(a) A person may not permit the emission into the outdoor atmosphere of particulate matter from a combustion unit in excess of the following:

(1) The rate of 0.4 pound per million Btu of heat input, when the heat input to the combustion unit in millions of Btus per hour is greater than 2.5 but less than 50.

(2)-(3) Not applicable.

(b) Not applicable.

002 [25 Pa. Code §123.22]**Combustion units**

(a)-(c) Not applicable.

(d) Allegheny County, Lower Beaver Valley, and Monongahela Valley air basins. Combustion units in these subject air basins must conform with the following:

(1) General provision. A person may not permit the emission into the outdoor atmosphere of sulfur oxides, expressed as SO₂, from a combustion unit in excess of one or more of the following:

(i) The rate of 1 pound per million Btu of heat input, when the heat input to the combustion unit in millions of Btus per hour is greater than 2.5 but less than 50.

(ii)-(iii) Not applicable.

(2) Commercial fuel oil.

(i) Except as specified in subparagraphs (ii) and (iii), a person may not offer for sale, deliver for use, exchange in trade or permit the use of commercial fuel oil in the subject air basins on or after July 1, 2016, if the commercial fuel oil contains sulfur in excess of the applicable maximum allowable sulfur content set forth in the following table:

Maximum Allowable Sulfur Content Beginning July 1, 2016,
Expressed as Parts per Million (ppm) by Weight or Percentage by Weight

Grades Commercial Fuel Oil (Consistent with ASTM D396)

No. 2 and lighter oil 500 ppm (0.05%)

No. 4 oil 2,500 ppm (0.25%)

**SECTION D. Source Level Requirements**

No. 5, No. 6 and heavier oil 5,000 ppm (0.5%)

(ii) Commercial fuel oil that was stored in this Commonwealth by the ultimate consumer prior to July 1, 2016, which met the applicable maximum allowable sulfur content at the time it was stored, may be used by the ultimate consumer in this Commonwealth on and after July 1, 2016.

(iii) Beginning July 1, 2016, the Department may temporarily suspend or increase the applicable maximum allowable sulfur content for a commercial fuel oil set forth in subparagraph (i) if the following occur:

(A) The Department receives a written request at the address specified in subsection (h) for a suspension or increase on the basis that compliant commercial fuel oil is not reasonably available in a subject air basin. The request must include the following:

(I) The subject air basin for which the suspension or increase is requested.

(II) The reason compliant commercial fuel oil is not reasonably available.

(III) The duration of time for which the suspension or increase is requested and the justification for the requested duration.

(B) The Department determines that an insufficient quantity of compliant commercial fuel oil is reasonably available in the air basin and that the circumstances leading to the insufficiency are due to events that could not have been reasonably foreseen or prevented and are not due to lack of prudent planning on the part of the transferor of the commercial fuel oil into or within the air basin.

(C) The Department approves the request, in writing, prior to the transferor distributing the noncompliant commercial fuel oil into or within the air basin.

(iv) The Department will limit a suspension or increase in the applicable maximum allowable sulfur content granted under subparagraph (iii) to the shortest duration in which adequate supplies of compliant commercial fuel oil can be made reasonably available, but in no case longer than 60 days from the date the Department grants the suspension or increase.

(3) Equivalency provision. Paragraph (2) does not apply to a person who uses equipment or a process, or to the owner or operator of an installation where equipment or a process is used, to reduce the sulfur emissions from the burning of a fuel with a higher sulfur content than that specified in paragraph (2). The emissions may not exceed those which would result from the use of commercial fuel oil that meets the applicable maximum allowable sulfur content specified in paragraph (2).

(e) Not applicable.

II. TESTING REQUIREMENTS.

No additional testing requirements exist except as provided in other sections of this permit including Section B (Title V General Requirements) and/or Section E (Source Group Restrictions).

III. MONITORING REQUIREMENTS.

No additional monitoring requirements exist except as provided in other sections of this permit including Section B (Title V General Requirements) and/or Section E (Source Group Restrictions).

IV. RECORDKEEPING REQUIREMENTS.

003 [25 Pa. Code §127.511]

Monitoring and related recordkeeping and reporting requirements.

The Owner/Operator shall maintain records of natural gas and fuel oil usage on a monthly basis.

**SECTION D. Source Level Requirements****# 004 [25 Pa. Code §127.511]****Monitoring and related recordkeeping and reporting requirements.**

The Owner/Operator shall maintain records containing, at a minimum, a certification of the sulfur content in the fuel oil from the supplier and a certification of sulfur content in the natural gas utilized in these sources. Records shall be maintained on site and made available to the Department upon request.

V. REPORTING REQUIREMENTS.**# 005 [25 Pa. Code §127.511]****Monitoring and related recordkeeping and reporting requirements.**

At a minimum, the permittee shall verify SO₂ emission rates using the most recent AP-42 emission factors or other appropriate methods with prior written approval from the Department.

006 [25 Pa. Code §127.511]**Monitoring and related recordkeeping and reporting requirements.**

At a minimum, the permittee shall verify particulate matter emission rates using the most recent AP-42 emission factors or other applicable methods with prior written approval from the Department.

VI. WORK PRACTICE REQUIREMENTS.

No additional work practice requirements exist except as provided in other sections of this permit including Section B (Title V General Requirements) and/or Section E (Source Group Restrictions).

VII. ADDITIONAL REQUIREMENTS.

No additional requirements exist except as provided in other sections of this permit including Section B (Title V General Requirements) and/or Section E (Source Group Restrictions).

***** Permit Shield in Effect. *****

**SECTION D. Source Level Requirements**

Source ID: 101

Source Name: CRYSTEX PLANT

Source Capacity/Throughput:

3.100 Tons/HR

INSOLUBLE SULFUR

Conditions for this source occur in the following groups: G02

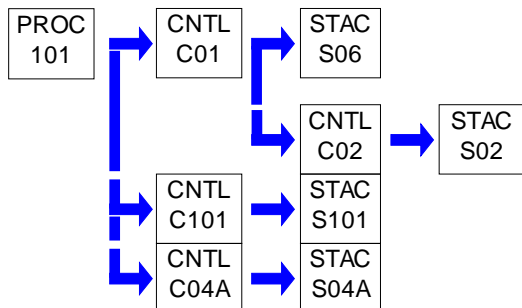

This source occurs in alternate operation BYPASS OF THERMAL OXIDIZER

I. RESTRICTIONS.**Emission Restriction(s).****# 001 [25 Pa. Code §123.13]****Processes**

In accordance with 25 Pa. Code Ch.123.13(c)(1)(i), the owner/operator shall not permit the emission into the outdoor atmosphere of particulate matter emissions from a process in a manner that the concentration of particulate matter in the effluent gas exceeds 0.04 grain per dry standard cubic foot.

002 [25 Pa. Code §127.12b]**Plan approval terms and conditions.**

In accordance with Plan Approval 63-313-029, Condition No. 7, hydrogen sulfide emissions from the thermal oxidizer shall not exceed 0.279 lbs/hr based upon a 3-hour block average.

003 [25 Pa. Code §127.12b]**Plan approval terms and conditions.**

In accordance with Plan Approval 63-313-029, Condition No.8, carbon disulfide emissions from the thermal oxidizer shall not exceed 0.1 lbs/hr based upon a 3-hour block average.

004 [25 Pa. Code §127.12b]**Plan approval terms and conditions.**

In accordance with Plan Approval 63-313-029, Condition No.6, the concentration (mass emission rate) of sulfur oxides (expressed as SO₂) from the thermal oxidizer shall not exceed 9.9 lbs/hr based upon a 3-hour block average and 34.5 tons on a rolling 12-month basis.

005 [25 Pa. Code §127.12b]**Plan approval terms and conditions.**

In accordance with Plan Approval PA 63-015A, Condition No.4, visible emissions from the Crystex plant packaging baghouse shall not exceed 10% opacity at any time. Compliance with this condition ensures compliance with Title 25 Pa. Code Section 123.41.

**SECTION D. Source Level Requirements****# 006 [25 Pa. Code §127.441]****Operating permit terms and conditions.**

In accordance with RACT Operating Permit 63-000-015, Condition No.6, VOC emissions from the Thermal Oxidizer Stack (Stack S02) shall not exceed 3.2 lbs/hr during normal operations. This limit does not apply during thermal oxidizer bypass conditions.

II. TESTING REQUIREMENTS.**# 007 [25 Pa. Code §127.12b]****Plan approval terms and conditions.**

In accordance with Plan Approval 63-313-029, Condition No.12, and 25 Pa. Code Section 139.11 (1), the Crystex plant shall be operated at the maximum average hourly feed rate to the thermal oxidizer and at maximum routine operating conditions, or under such other conditions within the capacity of the equipment as may be requested by the Department, during the performance test. Operating conditions shall be monitored, recorded and reported with the test results, verifying those process parameters which would indicate these conditions. The Operating Permit shall be restricted to the maximum average hourly operating or process rate at which compliance has been demonstrated.

008 [25 Pa. Code §127.441]**Operating permit terms and conditions.**

Performance testing shall be conducted as follows [25 Pa. Code §127.511 and §139.11]:

- a. The Owner/Operator shall submit three (3) copies of a pre-test protocol to the Department for review at least forty-five (45) days prior to the performance of any EPA Reference Method stack test. The Owner/Operator shall submit three copies of a one-time protocol to the Department for review for the use of a portable analyzer and may repeat portable analyzer testing without additional protocol approvals provided that the same method and equipment are used. All proposed performance test methods shall be identified in the pre-test protocol and approved by the Department prior to testing.
- b. The Owner/Operator shall notify the Regional Air Quality Manager at least fifteen (15) days prior to any performance test so that an observer may be present at the time of the test. This notification may be sent by email. Notification shall also be sent to the Division of Source Testing and Monitoring. Performance testing shall not be conducted except in accordance with an approved protocol.
- c. Pursuant to 40 CFR Part 60.8(a) and 40 CFR Part 63.9(h), a complete test report shall be submitted to the Department no later than sixty (60) calendar days after completion of the on-site testing portion of an emission test program.
- d. Pursuant to 25 Pa. Code Section 139.53(b) a complete test report shall include a summary of the emission results on the first page of the report indicating if each pollutant measured is within permitted limits and a statement of compliance or noncompliance with all applicable permit conditions. The summary results will include, at a minimum, the following information:
 1. A statement that the owner or operator has reviewed the report from the emissions testing body and agrees with the findings.
 2. Permit number(s) and condition(s) which are the basis for the evaluation.
 3. Summary of results with respect to each applicable permit condition.
 4. Statement of compliance or non-compliance with each applicable permit condition.
- e. Pursuant to 25 Pa. Code § 139.3 all submittals shall meet all applicable requirements specified in the most current version of the Department's Source Testing Manual.
- f. All testing shall be performed in accordance with the provisions of Chapter 139 of the Rules and Regulations of the Department of Environmental Protection.
- g. Pursuant to 25 Pa. Code Section 139.53(a)(1) and 139.53(a)(3) all submittals, besides notifications, shall be

**SECTION D. Source Level Requirements**

accomplished through PSIMS*Online available through <https://www.depgreenport.state.pa.us/ecommm/Login.jsp> when it becomes available. If internet submittal can not be accomplished, three copies of the submittal shall be sent to the Pennsylvania Department of Environmental Protection, Bureau of Air Quality, Division of Source Testing and Monitoring, 400 Market Street, 12th Floor Rachael Carson State Office Building, Harrisburg, PA 17105-8468 with deadlines verified through document postmarks.

h. The permittee shall ensure all federal reporting requirements contained in the applicable subpart of 40 CFR are followed, including timelines more stringent than those contained herein. In the event of an inconsistency or any conflicting requirements between state and the federal, the most stringent provision, term, condition, method or rule shall be used by default.

009 [25 Pa. Code §127.441]**Operating permit terms and conditions.**

The permittee shall determine destruction efficiency for TRS, total reduced sulfur (both inlet and outlet) of the thermal oxidizer through stack testing, at least once every five (5) years. Testing shall be performed within one (1) year of the date of issuance of the Title V permit and in accordance with the Title 25 Pa. Code Ch. 139 regulations and the Department's Source Testing Manual.

010 [25 Pa. Code §127.441]**Operating permit terms and conditions.**

The permittee shall determine emission rates for H₂S, CS₂ and SO_x, expressed as SO₂, through stack testing, at least once every five (5) years. Testing shall be performed within one (1) year of the date of issuance of the Title V permit and in accordance with the Title 25 Pa. Code Ch. 139 regulations and the Department's Source Testing Manual.

III. MONITORING REQUIREMENTS.**# 011 [25 Pa. Code §127.12b]****Plan approval terms and conditions.**

In accordance with Plan Approval 63-313-029, Condition No.5, the temperature of the thermal oxidizer shall be continuously monitored and recorded during operations. Temperature data records shall be maintained for a period of five (5) years and made available to the Department upon request.

012 [25 Pa. Code §127.511]**Monitoring and related recordkeeping and reporting requirements.**

The permittee shall install and maintain a carbon disulfide continuous emissions monitor in accordance with the manufacturer's specifications and operating manual.

013 [40 CFR Part 64 Compliance Assurance Monitoring for Major Stationary Sources §40 CFR 64.6]**Sections of PART 64****Approval of monitoring**

In accordance with the Compliance Assurance Monitoring (CAM) requirements of 40 CFR §§ 64.1-64.10 and based upon the source-specific information, this emission unit falls under 40 CFR §64.3(b)(4)(ii) and requires a continuous monitoring period. The continuous monitoring parameter identified is the oxidizer chamber control temperature. Periodic inspection of the control system's structural integrity was selected as a secondary performance indicator.

The following table represents the CAM plan for the Crystex Plant controlled by a thermal oxidizer:

I. Indicator - Measurement Approach

1. Oxidizer chamber temperature control - Continuously monitor the operating temperature of the oxidizer combustion chamber.
2. Work practice/inspection - Inspect internal and external structural integrity of oxidizer to ensure proper operation. Inspect



SECTION D. Source Level Requirements

burner operation and tune, as necessary.

3. Performance Test - Conduct emissions testing to demonstrate compliance with emissions limitations for carbon disulfide.

II. Indicator Range

1. An excursion is identified as a measurement of less than 1,200°F, based on a three-hour block average.
2. An excursion is identified as any finding that the structural integrity of the oxidizer has been jeopardized and it no longer operates as designed.
3. An excursion is identified with any finding that the oxidizer does not meet the permitted emissions limits.

III. QIP Threshold

1. Each excursion triggers an assessment of the problem, corrective action, and if the excursion has caused excess emissions, a reporting requirement.
2. Each excursion triggers an assessment of the problem, corrective action, and if the excursion has caused excess emissions, a reporting requirement.
3. Each excursion triggers an assessment of the problem, corrective action, and a reporting requirement.

IV. Performance Criteria

Data Representativeness

1. Any temperature-monitoring device employed to measure the oxidizer chamber temperature shall be accurate to within 0.5% of temperature measured or $\pm 5^{\circ}\text{F}$, whichever is greater.
2. Inspections of the oxidizer system will identify problems.
3. A test protocol shall be prepared and approved by regulatory agency prior to conducting the performance test.

Verification of Operational Status

1. Temperatures are monitored on a computer and can be recorded if needed.
2. Inspection records.
3. Not applicable.

QA/QC Practices and Criteria

1. Validation of temperature system conducted annually. Acceptance criteria $\pm 20^{\circ}\text{F}$.
2. Not Applicable.
3. EPA test methods approved protocol.

Monitoring Frequency

1. Measured continuously; "continuously" means at least one measurement taken every fifteen minutes unless otherwise specified.
2. External inspection, internal structure & burner inspection – performed annually; "annually" means within the calendar year during years with planned production shutdowns or, alternatively, no longer than 18 months since the last inspection.
3. Once every 5 years.

Data Collection Procedure

1. Recorded instantaneously on a computer and printed if necessary.
2. Record results of inspections and observations.
3. Per approved test method.

Averaging Period

1. Continuous temperature data shall be reduced to the average of three one-hour block averages of combustion chamber

**SECTION D. Source Level Requirements**

temperature. A valid hour of data shall include at least three measurements taken in three different quadrants (15-minute intervals) of the hour.

2. Not applicable.
3. Not applicable.

Record Keeping

1. Maintain for a period of 2 years. Flexsys is able to print from the computer memory.
2. Maintain a copy of the report for 2 years or until another test is conducted. Maintain records of corrective actions taken in response to excursions.
3. Submit test protocol and notification of testing to Agency.

Reporting Frequency

1. Annually.
2. Annually.
3. Term of the permit.

IV. RECORDKEEPING REQUIREMENTS.**# 014 [25 Pa. Code §127.12b]****Plan approval terms and conditions.**

In accordance with Plan Approval PA63-015A, Condition No.8, the permittee shall record and maintain data records from the carbon disulfide monitor for at least five (5) years and be made available to the Department upon request.

015 [25 Pa. Code §127.511]**Monitoring and related recordkeeping and reporting requirements.**

The permittee shall maintain records of all maintenance procedures performed on the carbon disulfide monitor, including, but not limited to, zero and span, all parameter display readings, replaced or repaired parts, and linearity tests. The information shall be maintained at the facility for a minimum of five (5) years, and shall be made available to an authorized Department representative at any time.

016 [25 Pa. Code §129.100]**Compliance demonstration and recordkeeping requirements.**

(a) - (c) Not applicable.

(d) The owner and operator of an air contamination source subject to this section and § § 129.96—129.99 shall keep records to demonstrate compliance with § § 129.96—129.99 in the following manner:

(1) The records must include sufficient data and calculations to demonstrate that the requirements of § § 129.96—129.99 are met.

(2) Data or information required to determine compliance shall be recorded and maintained in a time frame consistent with the averaging period of the requirement.

(e) - (h) Not applicable.

(i) The records shall be retained by the owner or operator for 5 years and made available to the Department or appropriate approved local air pollution control agency upon receipt of a written request from the Department or appropriate approved local air pollution control agency.

**SECTION D. Source Level Requirements****# 017 [25 Pa. Code §129.100]****Compliance demonstration and recordkeeping requirements.**

Auditory, Visual, and Olfactory (AVO) inspections of the carbon disulfide containing portions of the facility shall be made at least monthly and a record of the inspection along with instrument monitoring results taken during the inspection be retained. The AVO records shall be retained on-site for a minimum of five (5) years. These records shall be made available to the Department upon request.

V. REPORTING REQUIREMENTS.**# 018 [25 Pa. Code §127.511]****Monitoring and related recordkeeping and reporting requirements.**

At a minimum, the permittee shall verify particulate matter emission rates using the most recent AP-42 emission factors or other applicable methods with prior written approval from the Department.

019 [25 Pa. Code §127.511]**Monitoring and related recordkeeping and reporting requirements.**

At a minimum, the permittee shall verify SO₂ emission rates using the most recent stack testing data, material balance methods, the most current AP-42 emission factors or other applicable methods with prior written approval from the Department.

VI. WORK PRACTICE REQUIREMENTS.**# 020 [25 Pa. Code §127.12b]****Plan approval terms and conditions.**

In accordance with Plan Approval 63-313-029, Condition No.9, the minimum destruction efficiency of the thermal oxidizer for total reduced sulfur (TRS) compounds shall not be less than 95%.

021 [25 Pa. Code §127.12b]**Plan approval terms and conditions.**

In accordance with Plan Approval 63-313-029, Condition No.4, the thermal oxidizer shall be maintained to operate at a minimum outlet temperature of 1,200 degrees F and a minimum residence time of 0.3 seconds.

022 [25 Pa. Code §127.511]**Monitoring and related recordkeeping and reporting requirements.**

The permittee shall conduct zero and span checks on the carbon disulfide monitor, at a minimum, of once per every two weeks.

VII. ADDITIONAL REQUIREMENTS.**# 023 [25 Pa. Code §129.96]****Applicability**

(a) The NO_x requirements of this section and § § 129.97—129.100 apply Statewide to the owner and operator of a major NO_x emitting facility and the VOC requirements of this section and § § 129.97—129.100 apply Statewide to the owner and operator of a major VOC emitting facility that were in existence on or before July 20, 2012, for which a requirement or emission limitation, or both, has not been established in § § 129.51—129.52c, 129.54—129.69, 129.71—129.73, 129.75, 129.77, 129.101—129.107 and 129.301—129.310.

(b) Not applicable.

(c) This section and § § 129.97—129.100 do not apply to the owner and operator of a NO_x air contamination source located at a major NO_x emitting facility that has the potential to emit less than 1 TPY of NO_x or a VOC air contamination source

**SECTION D. Source Level Requirements**

located at a major VOC emitting facility that has the potential to emit less than 1 TPY of VOC.

(d) Not applicable.

***** Permit Shield in Effect. *****

**SECTION D. Source Level Requirements**

Source ID: 115

Source Name: SULFUR RAILCAR UNLOADING

Source Capacity/Throughput:

50.000 Tons/HR

SULFUR RAILCARS

Conditions for this source occur in the following groups: G01
G02

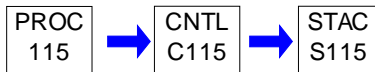
**I. RESTRICTIONS.****Emission Restriction(s).****# 001 [25 Pa. Code §127.441]****Operating permit terms and conditions.**

In accordance with Plan Approval PA 63-015B, Condition No.4, the emissions from the H2S adsorber shall be limited as follows;

- a. 0.30 lbs/hour of H2S;
- b. 0.04 tons of H2S on a 12-month rolling basis.

II. TESTING REQUIREMENTS.

No additional testing requirements exist except as provided in other sections of this permit including Section B (Title V General Requirements) and/or Section E (Source Group Restrictions).

III. MONITORING REQUIREMENTS.**# 002 [25 Pa. Code §127.441]****Operating permit terms and conditions.**

In accordance with Plan Approval PA 63-015B, Condition No.8, the permittee shall, once per shift during the venting and depressurization of a railcar, conduct a malodor survey and a visible emission survey at Department approved survey spots to ensure compliance with Section C. Site Level Requirements, Conditions #004 and #005. Written statements describing these surveys shall be maintained in a log at the facility for a minimum of five (5) years and shall be made available to an authorized Department representative upon request.

003 [25 Pa. Code §127.441]**Operating permit terms and conditions.**

In accordance with Plan Approval PA 63-015B, Condition No.9, at a minimum of once per quarter, the permittee shall sample outlet H2S using a Draeger tube or equivalent methodology. The sampling shall be done to ensure appropriate operation and prevent plugging of the adsorption unit. The results shall be maintained in a log at the facility for a minimum of five (5) years and shall be made available to an authorized Department representative upon request.

IV. RECORDKEEPING REQUIREMENTS.**# 004 [25 Pa. Code §127.441]****Operating permit terms and conditions.**

In accordance with Plan Approval PA 63-015B, Condition No.10, the permittee shall collect and record the applicable information specified in this Condition. The information shall be maintained at the facility for a minimum of five (5) years and shall be made available to an authorized Department representative upon request. The information required is:

**SECTION D. Source Level Requirements**

- a. The permittee shall maintain monthly records of the number of railcars processed;
- b. For each month of operation, an estimate of H₂S emissions during the latest 12-month period.

V. REPORTING REQUIREMENTS.

No additional reporting requirements exist except as provided in other sections of this permit including Section B (Title V General Requirements) and/or Section E (Source Group Restrictions).

VI. WORK PRACTICE REQUIREMENTS.

No additional work practice requirements exist except as provided in other sections of this permit including Section B (Title V General Requirements) and/or Section E (Source Group Restrictions).

VII. ADDITIONAL REQUIREMENTS.

No additional requirements exist except as provided in other sections of this permit including Section B (Title V General Requirements) and/or Section E (Source Group Restrictions).

***** Permit Shield in Effect. *****

**SECTION D. Source Level Requirements**

Source ID: 117

Source Name: SULFUR STORAGE TANKS

Source Capacity/Throughput: 1,200.000 Gal/HR SULFUR

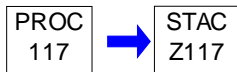
Conditions for this source occur in the following groups: G01
G02**I. RESTRICTIONS.**

No additional requirements exist except as provided in other sections of this permit including Section B (Title V General Requirements) and/or Section E (Source Group Restrictions).

II. TESTING REQUIREMENTS.

No additional testing requirements exist except as provided in other sections of this permit including Section B (Title V General Requirements) and/or Section E (Source Group Restrictions).

III. MONITORING REQUIREMENTS.

No additional monitoring requirements exist except as provided in other sections of this permit including Section B (Title V General Requirements) and/or Section E (Source Group Restrictions).

IV. RECORDKEEPING REQUIREMENTS.

No additional record keeping requirements exist except as provided in other sections of this permit including Section B (Title V General Requirements) and/or Section E (Source Group Restrictions).

V. REPORTING REQUIREMENTS.

No additional reporting requirements exist except as provided in other sections of this permit including Section B (Title V General Requirements) and/or Section E (Source Group Restrictions).

VI. WORK PRACTICE REQUIREMENTS.

No additional work practice requirements exist except as provided in other sections of this permit including Section B (Title V General Requirements) and/or Section E (Source Group Restrictions).

VII. ADDITIONAL REQUIREMENTS.

No additional requirements exist except as provided in other sections of this permit including Section B (Title V General Requirements) and/or Section E (Source Group Restrictions).

***** Permit Shield in Effect. *****

**SECTION D. Source Level Requirements**

Source ID: 123

Source Name: PROCESS OIL TANK #1

Source Capacity/Throughput: 3,000.000 Gal/HR PROCESS OIL

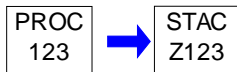
Conditions for this source occur in the following groups: G01
G02**I. RESTRICTIONS.**

No additional requirements exist except as provided in other sections of this permit including Section B (Title V General Requirements) and/or Section E (Source Group Restrictions).

II. TESTING REQUIREMENTS.

No additional testing requirements exist except as provided in other sections of this permit including Section B (Title V General Requirements) and/or Section E (Source Group Restrictions).

III. MONITORING REQUIREMENTS.

No additional monitoring requirements exist except as provided in other sections of this permit including Section B (Title V General Requirements) and/or Section E (Source Group Restrictions).

IV. RECORDKEEPING REQUIREMENTS.

No additional record keeping requirements exist except as provided in other sections of this permit including Section B (Title V General Requirements) and/or Section E (Source Group Restrictions).

V. REPORTING REQUIREMENTS.

No additional reporting requirements exist except as provided in other sections of this permit including Section B (Title V General Requirements) and/or Section E (Source Group Restrictions).

VI. WORK PRACTICE REQUIREMENTS.

No additional work practice requirements exist except as provided in other sections of this permit including Section B (Title V General Requirements) and/or Section E (Source Group Restrictions).

VII. ADDITIONAL REQUIREMENTS.

No additional requirements exist except as provided in other sections of this permit including Section B (Title V General Requirements) and/or Section E (Source Group Restrictions).

***** Permit Shield in Effect. *****

**SECTION D. Source Level Requirements**

Source ID: 124

Source Name: PROCESS OIL TANK #2

Source Capacity/Throughput: 3,000.000 Gal/HR PROCESS OIL

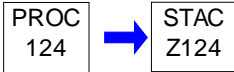
Conditions for this source occur in the following groups: G01
G02**I. RESTRICTIONS.**

No additional requirements exist except as provided in other sections of this permit including Section B (Title V General Requirements) and/or Section E (Source Group Restrictions).

II. TESTING REQUIREMENTS.

No additional testing requirements exist except as provided in other sections of this permit including Section B (Title V General Requirements) and/or Section E (Source Group Restrictions).

III. MONITORING REQUIREMENTS.

No additional monitoring requirements exist except as provided in other sections of this permit including Section B (Title V General Requirements) and/or Section E (Source Group Restrictions).

IV. RECORDKEEPING REQUIREMENTS.

No additional record keeping requirements exist except as provided in other sections of this permit including Section B (Title V General Requirements) and/or Section E (Source Group Restrictions).

V. REPORTING REQUIREMENTS.

No additional reporting requirements exist except as provided in other sections of this permit including Section B (Title V General Requirements) and/or Section E (Source Group Restrictions).

VI. WORK PRACTICE REQUIREMENTS.

No additional work practice requirements exist except as provided in other sections of this permit including Section B (Title V General Requirements) and/or Section E (Source Group Restrictions).

VII. ADDITIONAL REQUIREMENTS.

No additional requirements exist except as provided in other sections of this permit including Section B (Title V General Requirements) and/or Section E (Source Group Restrictions).

***** Permit Shield in Effect. *****

**SECTION D. Source Level Requirements**

Source ID: 125

Source Name: TANK TRUCK UNLOADING OF SULFUR

Source Capacity/Throughput: 22.000 Tons/HR

Conditions for this source occur in the following groups: G02

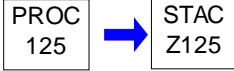
**I. RESTRICTIONS.**

No additional requirements exist except as provided in other sections of this permit including Section B (Title V General Requirements) and/or Section E (Source Group Restrictions).

II. TESTING REQUIREMENTS.

No additional testing requirements exist except as provided in other sections of this permit including Section B (Title V General Requirements) and/or Section E (Source Group Restrictions).

III. MONITORING REQUIREMENTS.

No additional monitoring requirements exist except as provided in other sections of this permit including Section B (Title V General Requirements) and/or Section E (Source Group Restrictions).

IV. RECORDKEEPING REQUIREMENTS.

No additional record keeping requirements exist except as provided in other sections of this permit including Section B (Title V General Requirements) and/or Section E (Source Group Restrictions).

V. REPORTING REQUIREMENTS.

No additional reporting requirements exist except as provided in other sections of this permit including Section B (Title V General Requirements) and/or Section E (Source Group Restrictions).

VI. WORK PRACTICE REQUIREMENTS.

No additional work practice requirements exist except as provided in other sections of this permit including Section B (Title V General Requirements) and/or Section E (Source Group Restrictions).

VII. ADDITIONAL REQUIREMENTS.

No additional requirements exist except as provided in other sections of this permit including Section B (Title V General Requirements) and/or Section E (Source Group Restrictions).

***** Permit Shield in Effect. *****

**SECTION D. Source Level Requirements**

Source ID: 201

Source Name: EMERGENCY DIESEL GENERATOR (226 BHP)

Source Capacity/Throughput:

12.000 Gal/HR

Diesel Fuel

Conditions for this source occur in the following groups: G01
G02

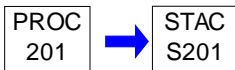
**I. RESTRICTIONS.****Emission Restriction(s).****# 001 [25 Pa. Code §123.13]****Processes**

In accordance with 25 Pa. Code Ch.123.13(c)(1)(i), the owner/operator shall not permit the emission into the outdoor atmosphere of particulate matter emissions from a process in a manner that the concentration of particulate matter in the effluent gas exceeds 0.04 grain per dry standard cubic foot.

002 [25 Pa. Code §123.21]**General**

(a) This section applies to sources except those subject to other provisions of this article, with respect to the control of sulfur compound emissions.

(b) No person may permit the emission into the outdoor atmosphere of sulfur oxides from a source in a manner that the concentration of the sulfur oxides, expressed as SO₂, in the effluent gas exceeds 500 parts per million, by volume, dry basis.

II. TESTING REQUIREMENTS.

No additional testing requirements exist except as provided in other sections of this permit including Section B (Title V General Requirements) and/or Section E (Source Group Restrictions).

III. MONITORING REQUIREMENTS.**# 003 [40 CFR Part 63 NESHAPS for Source Categories §40 CFR 63.6625]****Subpart ZZZZ - National Emissions Standards for Hazardous Air Pollutants for Stationary Reciprocating Internal Combustion Engines****What are my monitoring, installation, operation, and maintenance requirements?**

(a) - (d) Not applicable.

(e) If you own or operate any of the following stationary RICE, you must operate and maintain the stationary RICE and after-treatment control device (if any) according to the manufacturer's emission-related written instructions or develop your own maintenance plan which must provide to the extent practicable for the maintenance and operation of the engine in a manner consistent with good air pollution control practice for minimizing emissions:

(1) Not applicable.

(2) An existing emergency or black start stationary RICE with a site rating of less than or equal to 500 HP located at a major source of HAP emissions.

(3) - (9) Not applicable.

(f) If you own or operate an existing emergency stationary RICE with a site rating of less than or equal to 500 brake HP located at a major source of HAP emissions or an existing emergency stationary RICE located at an area source of HAP emissions, you must install a non-resettable hour meter if one is not already installed.

**SECTION D. Source Level Requirements**

(g) Not applicable.

(h) If you operate a new, reconstructed, or existing stationary engine, you must minimize the engine's time spent at idle during startup and minimize the engine's startup time to a period needed for appropriate and safe loading of the engine, not to exceed 30 minutes, after which time the emission standards applicable to all times other than startup in Tables 1a, 2a, 2c, and 2d to this subpart apply.

(i) - (j) Not applicable.

IV. RECORDKEEPING REQUIREMENTS.

004 [40 CFR Part 63 NESHAPS for Source Categories §40 CFR 63.6655]

Subpart ZZZZ - National Emissions Standards for Hazardous Air Pollutants for Stationary Reciprocating Internal Combustion Engines

What records must I keep?

(a) If you must comply with the emission and operating limitations, you must keep the records described in paragraphs (a)(1) through (a)(5), (b)(1) through (b)(3) and (c) of this section.

(1) - (4) Not applicable.

(5) Records of actions taken during periods of malfunction to minimize emissions in accordance with §63.6605(b), including corrective actions to restore malfunctioning process and air pollution control and monitoring equipment to its normal or usual manner of operation.

(b) - (d) Not applicable.

(e) You must keep records of the maintenance conducted on the stationary RICE in order to demonstrate that you operated and maintained the stationary RICE and after-treatment control device (if any) according to your own maintenance plan if you own or operate any of the following stationary RICE;

(1) Not applicable.

(2) An existing stationary emergency RICE.

(3) Not applicable.

(f) If you own or operate any of the stationary RICE in paragraphs (f)(1) through (2) of this section, you must keep records of the hours of operation of the engine that is recorded through the non-resettable hour meter. The owner or operator must document how many hours are spent for emergency operation, including what classified the operation as emergency and how many hours are spent for non-emergency operation. If the engine is used for the purposes specified in §63.6640(f)(2)(ii) or (iii) or §63.6640(f)(4)(ii), the owner or operator must keep records of the notification of the emergency situation, and the date, start time, and end time of engine operation for these purposes.

(1) An existing emergency stationary RICE with a site rating of less than or equal to 500 brake HP located at a major source of HAP emissions that does not meet the standards applicable to non-emergency engines.

(2) Not applicable.

V. REPORTING REQUIREMENTS.

No additional reporting requirements exist except as provided in other sections of this permit including Section B (Title V General Requirements) and/or Section E (Source Group Restrictions).

VI. WORK PRACTICE REQUIREMENTS.

005 [25 Pa. Code §127.511]

Monitoring and related recordkeeping and reporting requirements.

Table 2c to Subpart ZZZZ of Part 63—Requirements for Existing Compression Ignition Stationary RICE Located at a Major

**SECTION D. Source Level Requirements**

Source of HAP Emissions and Existing Spark Ignition Stationary RICE ≤ 500 HP Located at a Major Source of HAP Emissions

As stated in §§63.6600, 63.6602, and 63.6640, you must comply with the following requirements for existing compression ignition stationary RICE located at a major source of HAP emissions and existing spark ignition stationary RICE ≤ 500 HP located at a major source of HAP emissions:

For each . . .

1. Emergency stationary CI RICE and black start stationary CI RICE*

You must meet the following requirement, except during periods of startup . . .

- a. Change oil and filter every 500 hours of operation or annually, whichever comes first.**
- b. Inspect air cleaner every 1,000 hours of operation or annually, whichever comes first, and replace as necessary;
- c. Inspect all hoses and belts every 500 hours of operation or annually, whichever comes first, and replace as necessary.***

During periods of startup you must . . .

Minimize the engine's time spent at idle and minimize the engine's startup time at startup to a period needed for appropriate and safe loading of the engine, not to exceed 30 minutes, after which time the non-startup emission limitations apply.***

* If an emergency engine is operating during an emergency and it is not possible to shut down the engine in order to perform the work practice requirements on the schedule required in Table 2c of this subpart, or if performing the work practice on the required schedule would otherwise pose an unacceptable risk under federal, state, or local law, the work practice can be delayed until the emergency is over or the unacceptable risk under federal, state, or local law has abated. The work practice should be performed as soon as practicable after the emergency has ended or the unacceptable risk under federal, state, or local law has abated. Sources must report any failure to perform the work practice on the schedule required and the federal, state or local law under which the risk was deemed unacceptable.

** Sources have the option to utilize an oil analysis program as described in §63.6625(i) or (j) in order to extend the specified oil change requirement in Table 2c of this subpart.

*** Sources can petition the Administrator pursuant to the requirements of 40 CFR 63.6(g) for alternative work practices.

006 [40 CFR Part 63 NESHAPS for Source Categories §40 CFR 63 Subpart ZZZZ Table 6]

Subpart ZZZZ - National Emissions Standards for Hazardous Air Pollutants for Stationary Reciprocating Internal Combustion Engines

Table 6 to Subpart ZZZZ of Part 63.-- Continuous Compliance With Emission Limitations and Operating Limitations

As stated in §63.6640, you must continuously comply with the emissions and operating limitations and work or management practices as required by the following:

For each . . .

9. Existing emergency and black start stationary RICE ≤ 500 HP located at a major source of HAP

Complying with the requirement to . . .

a. Work or Management practices

You must demonstrate continuous compliance by . . .

- i. Operating and maintaining the stationary RICE according to the manufacturer's emission-related operation and maintenance instructions; or

**SECTION D. Source Level Requirements**

ii. Develop and follow your own maintenance plan which must provide to the extent practicable for the maintenance and operation of the engine in a manner consistent with good air pollution control practice for minimizing emissions.

007 [40 CFR Part 63 NESHAPS for Source Categories §40 CFR 63.6602]**Subpart ZZZZ - National Emissions Standards for Hazardous Air Pollutants for Stationary Reciprocating Internal Combustion Engines****What emission limitations must I meet if I own or operate an existing stationary RICE with a site rating of equal to or less than 500 brake HP located at a major source of HAP emissions?**

If you own or operate an existing stationary RICE with a site rating of equal to or less than 500 brake HP located at a major source of HAP emissions, you must comply with the emission limitations and other requirements in Table 2c to this subpart which apply to you.

008 [40 CFR Part 63 NESHAPS for Source Categories §40 CFR 63.6605]**Subpart ZZZZ - National Emissions Standards for Hazardous Air Pollutants for Stationary Reciprocating Internal Combustion Engines****What are my general requirements for complying with this subpart?**

(a) You must be in compliance with the emission limitations, operating limitations, and other requirements in this subpart that apply to you at all times.

(b) At all times you must operate and maintain any affected source, including associated air pollution control equipment and monitoring equipment, in a manner consistent with safety and good air pollution control practices for minimizing emissions. The general duty to minimize emissions does not require you to make any further efforts to reduce emissions if levels required by this standard have been achieved. Determination of whether such operation and maintenance procedures are being used will be based on information available to the Administrator which may include, but is not limited to, monitoring results, review of operation and maintenance records, and inspection of the source.

009 [40 CFR Part 63 NESHAPS for Source Categories §40 CFR 63.6640]**Subpart ZZZZ - National Emissions Standards for Hazardous Air Pollutants for Stationary Reciprocating Internal Combustion Engines****How do I demonstrate continuous compliance with the emission limitations, operating limitations, and other requirements?**

(a) You must demonstrate continuous compliance with each emission limitation, operating limitation, and other requirements in Tables 1a and 1b, Tables 2a and 2b, Table 2c, and Table 2d to this subpart that apply to you according to methods specified in Table 6 to this subpart.

(b) You must report each instance in which you did not meet each emission limitation or operating limitation in Tables 1a and 1b, Tables 2a and 2b, Table 2c, and Table 2d to this subpart that apply to you. These instances are deviations from the emission and operating limitations in this subpart. These deviations must be reported according to the requirements in §63.6650. If you change your catalyst, you must reestablish the values of the operating parameters measured during the initial performance test. When you reestablish the values of your operating parameters, you must also conduct a performance test to demonstrate that you are meeting the required emission limitation applicable to your stationary RICE.

(c) - (e) Not applicable.

(f) If you own or operate an emergency stationary RICE, you must operate the emergency stationary RICE according to the requirements in paragraphs (f)(1) through (4) of this section. In order for the engine to be considered an emergency stationary RICE under this subpart, any operation other than emergency operation, maintenance and testing, emergency demand response, and operation in non-emergency situations for 50 hours per year, as described in paragraphs (f)(1) through (4) of this section, is prohibited. If you do not operate the engine according to the requirements in paragraphs (f)(1) through (4) of this section, the engine will not be considered an emergency engine under this subpart and must meet all requirements for non-emergency engines.

(1) There is no time limit on the use of emergency stationary RICE in emergency situations.

**SECTION D. Source Level Requirements**

(2) You may operate your emergency stationary RICE for any combination of the purposes specified in paragraphs (f)(2)(i) through (iii) of this section for a maximum of 100 hours per calendar year. Any operation for non-emergency situations as allowed by paragraphs (f)(3) and (4) of this section counts as part of the 100 hours per calendar year allowed by this paragraph (f)(2).

(i) Emergency stationary RICE may be operated for maintenance checks and readiness testing, provided that the tests are recommended by federal, state or local government, the manufacturer, the vendor, the regional transmission organization or equivalent balancing authority and transmission operator, or the insurance company associated with the engine. The owner or operator may petition the Administrator for approval of additional hours to be used for maintenance checks and readiness testing, but a petition is not required if the owner or operator maintains records indicating that federal, state, or local standards require maintenance and testing of emergency RICE beyond 100 hours per calendar year.

(ii) Emergency stationary RICE may be operated for emergency demand response for periods in which the Reliability Coordinator under the North American Electric Reliability Corporation (NERC) Reliability Standard EOP-002-3, Capacity and Energy Emergencies (incorporated by reference, see §63.14), or other authorized entity as determined by the Reliability Coordinator, has declared an Energy Emergency Alert Level 2 as defined in the NERC Reliability Standard EOP-002-3.

(iii) Emergency stationary RICE may be operated for periods where there is a deviation of voltage or frequency of 5 percent or greater below standard voltage or frequency.

(3) Emergency stationary RICE located at major sources of HAP may be operated for up to 50 hours per calendar year in non-emergency situations. The 50 hours of operation in non-emergency situations are counted as part of the 100 hours per calendar year for maintenance and testing and emergency demand response provided in paragraph (f)(2) of this section. The 50 hours per year for non-emergency situations cannot be used for peak shaving or non-emergency demand response, or to generate income for a facility to supply power to an electric grid or otherwise supply power as part of a financial arrangement with another entity.

(4) Not applicable.

VII. ADDITIONAL REQUIREMENTS.**# 010 [40 CFR Part 63 NESHAPS for Source Categories §40 CFR 63.6585]****Subpart ZZZZ - National Emissions Standards for Hazardous Air Pollutants for Stationary Reciprocating Internal Combustion Engines****Am I subject to this subpart?**

You are subject to this subpart if you own or operate a stationary RICE at a major or area source of HAP emissions, except if the stationary RICE is being tested at a stationary RICE test cell/stand.

(a) A stationary RICE is any internal combustion engine which uses reciprocating motion to convert heat energy into mechanical work and which is not mobile. Stationary RICE differ from mobile RICE in that a stationary RICE is not a non-road engine as defined at 40 CFR 1068.30, and is not used to propel a motor vehicle or a vehicle used solely for competition.

(b) A major source of HAP emissions is a plant site that emits or has the potential to emit any single HAP at a rate of 10 tons (9.07 megagrams) or more per year or any combination of HAP at a rate of 25 tons (22.68 megagrams) or more per year, except that for oil and gas production facilities, a major source of HAP emissions is determined for each surface site.

(c) An area source of HAP emissions is a source that is not a major source.

(d) - (f) Not applicable.

011 [40 CFR Part 63 NESHAPS for Source Categories §40 CFR 63.6590]**Subpart ZZZZ - National Emissions Standards for Hazardous Air Pollutants for Stationary Reciprocating Internal Combustion Engines**

**SECTION D. Source Level Requirements****What parts of my plant does this subpart cover?**

This subpart applies to each affected source.

(a) Affected source. An affected source is any existing, new, or reconstructed stationary RICE located at a major or area source of HAP emissions, excluding stationary RICE being tested at a stationary RICE test cell/stand.

(1) Existing stationary RICE.

(i) Not applicable.

(ii) For stationary RICE with a site rating of less than or equal to 500 brake HP located at a major source of HAP emissions, a stationary RICE is existing if you commenced construction or reconstruction of the stationary RICE before June 12, 2006.

(iii) - (iv) Not applicable.

(2) Not applicable.

(3) Not applicable.

(b) Not applicable.

(c) Not applicable.

012 [40 CFR Part 63 NESHAPS for Source Categories §40 CFR 63.6595]

Subpart ZZZZ - National Emissions Standards for Hazardous Air Pollutants for Stationary Reciprocating Internal Combustion Engines

When do I have to comply with this subpart?

(a) Affected sources. (1) If you have an existing stationary CI RICE with a site rating of less than or equal to 500 brake HP located at a major source of HAP emissions, you must comply with the applicable emission limitations, operating limitations, and other requirements no later than May 3, 2013.

***** Permit Shield in Effect. *****

**SECTION D. Source Level Requirements**

(h) If you operate a new, reconstructed, or existing stationary engine, you must minimize the engine's time spent at idle during startup and minimize the engine's startup time to a period needed for appropriate and safe loading of the engine, not to exceed 30 minutes, after which time the emission standards applicable to all times other than startup in Tables 1a, 2a, 2c, and 2d to this subpart apply.

(i) - (j) Not applicable.

IV. RECORDKEEPING REQUIREMENTS.**# 004 [40 CFR Part 63 NESHAPS for Source Categories §40 CFR 63.6655]****Subpart ZZZZ - National Emissions Standards for Hazardous Air Pollutants for Stationary Reciprocating Internal Combustion Engines****What records must I keep?**

(a) If you must comply with the emission and operating limitations, you must keep the records described in paragraphs (a)(1) through (a)(5), (b)(1) through (b)(3) and (c) of this section.

(1) - (4) Not applicable.

(5) Records of actions taken during periods of malfunction to minimize emissions in accordance with §63.6605(b), including corrective actions to restore malfunctioning process and air pollution control and monitoring equipment to its normal or usual manner of operation.

(b) - (d) Not applicable.

(e) You must keep records of the maintenance conducted on the stationary RICE in order to demonstrate that you operated and maintained the stationary RICE and after-treatment control device (if any) according to your own maintenance plan if you own or operate any of the following stationary RICE;

(1) Not applicable.

(2) An existing stationary emergency RICE.

(3) Not applicable.

(f) If you own or operate any of the stationary RICE in paragraphs (f)(1) through (2) of this section, you must keep records of the hours of operation of the engine that is recorded through the non-resettable hour meter. The owner or operator must document how many hours are spent for emergency operation, including what classified the operation as emergency and how many hours are spent for non-emergency operation. If the engine is used for the purposes specified in §63.6640(f)(2)(ii) or (iii) or §63.6640(f)(4)(ii), the owner or operator must keep records of the notification of the emergency situation, and the date, start time, and end time of engine operation for these purposes.

(1) An existing emergency stationary RICE with a site rating of less than or equal to 500 brake HP located at a major source of HAP emissions that does not meet the standards applicable to non-emergency engines.

(2) Not applicable.

V. REPORTING REQUIREMENTS.

No additional reporting requirements exist except as provided in other sections of this permit including Section B (Title V General Requirements) and/or Section E (Source Group Restrictions).

VI. WORK PRACTICE REQUIREMENTS.**# 005 [25 Pa. Code §127.511]****Monitoring and related recordkeeping and reporting requirements.**

Table 2c to Subpart ZZZZ of Part 63—Requirements for Existing Compression Ignition Stationary RICE Located at a Major Source of HAP Emissions and Existing Spark Ignition Stationary RICE
 <= 500 HP Located at a Major Source of HAP Emissions

**SECTION D. Source Level Requirements**

As stated in §§63.6600, 63.6602, and 63.6640, you must comply with the following requirements for existing compression ignition stationary RICE located at a major source of HAP emissions and existing spark ignition stationary RICE \leq 500 HP located at a major source of HAP emissions:

For each . . .

1. Emergency stationary CI RICE and black start stationary CI RICE*

You must meet the following requirement, except during periods of startup . . .

- a. Change oil and filter every 500 hours of operation or annually, whichever comes first.**
- b. Inspect air cleaner every 1,000 hours of operation or annually, whichever comes first, and replace as necessary;
- c. Inspect all hoses and belts every 500 hours of operation or annually, whichever comes first, and replace as necessary.***

During periods of startup you must . . .

Minimize the engine's time spent at idle and minimize the engine's startup time at startup to a period needed for appropriate and safe loading of the engine, not to exceed 30 minutes, after which time the non-startup emission limitations apply.***

* If an emergency engine is operating during an emergency and it is not possible to shut down the engine in order to perform the work practice requirements on the schedule required in Table 2c of this subpart, or if performing the work practice on the required schedule would otherwise pose an unacceptable risk under federal, state, or local law, the work practice can be delayed until the emergency is over or the unacceptable risk under federal, state, or local law has abated. The work practice should be performed as soon as practicable after the emergency has ended or the unacceptable risk under federal, state, or local law has abated. Sources must report any failure to perform the work practice on the schedule required and the federal, state or local law under which the risk was deemed unacceptable.

** Sources have the option to utilize an oil analysis program as described in §63.6625(i) or (j) in order to extend the specified oil change requirement in Table 2c of this subpart.

*** Sources can petition the Administrator pursuant to the requirements of 40 CFR 63.6(g) for alternative work practices.

006 [40 CFR Part 63 NESHAPS for Source Categories §40 CFR 63 Subpart ZZZZ Table 6]

Subpart ZZZZ - National Emissions Standards for Hazardous Air Pollutants for Stationary Reciprocating Internal Combustion Engines

Table 6 to Subpart ZZZZ of Part 63.-- Continuous Compliance With Emission Limitations and Operating Limitations

As stated in §63.6640, you must continuously comply with the emissions and operating limitations and work or management practices as required by the following:

For each . . .

9. Existing emergency and black start stationary RICE \leq 500 HP located at a major source of HAP

Complying with the requirement to . . .

- a. Work or Management practices

You must demonstrate continuous compliance by . . .

- i. Operating and maintaining the stationary RICE according to the manufacturer's emission-related operation and maintenance instructions; or
- ii. Develop and follow your own maintenance plan which must provide to the extent practicable for the maintenance and operation of the engine in a manner consistent with good air pollution control practice for minimizing emissions.

**SECTION D. Source Level Requirements****# 007 [40 CFR Part 63 NESHAPS for Source Categories §40 CFR 63.6602]****Subpart ZZZZ - National Emissions Standards for Hazardous Air Pollutants for Stationary Reciprocating Internal Combustion Engines****What emission limitations must I meet if I own or operate an existing stationary RICE with a site rating of equal to or less than 500 brake HP located at a major source of HAP emissions?**

If you own or operate an existing stationary RICE with a site rating of equal to or less than 500 brake HP located at a major source of HAP emissions, you must comply with the emission limitations and other requirements in Table 2c to this subpart which apply to you.

008 [40 CFR Part 63 NESHAPS for Source Categories §40 CFR 63.6605]**Subpart ZZZZ - National Emissions Standards for Hazardous Air Pollutants for Stationary Reciprocating Internal Combustion Engines****What are my general requirements for complying with this subpart?**

(a) You must be in compliance with the emission limitations, operating limitations, and other requirements in this subpart that apply to you at all times.

(b) At all times you must operate and maintain any affected source, including associated air pollution control equipment and monitoring equipment, in a manner consistent with safety and good air pollution control practices for minimizing emissions. The general duty to minimize emissions does not require you to make any further efforts to reduce emissions if levels required by this standard have been achieved. Determination of whether such operation and maintenance procedures are being used will be based on information available to the Administrator which may include, but is not limited to, monitoring results, review of operation and maintenance records, and inspection of the source.

009 [40 CFR Part 63 NESHAPS for Source Categories §40 CFR 63.6640]**Subpart ZZZZ - National Emissions Standards for Hazardous Air Pollutants for Stationary Reciprocating Internal Combustion Engines****How do I demonstrate continuous compliance with the emission limitations, operating limitations, and other requirements?**

(a) You must demonstrate continuous compliance with each emission limitation, operating limitation, and other requirements in Tables 1a and 1b, Tables 2a and 2b, Table 2c, and Table 2d to this subpart that apply to you according to methods specified in Table 6 to this subpart.

(b) You must report each instance in which you did not meet each emission limitation or operating limitation in Tables 1a and 1b, Tables 2a and 2b, Table 2c, and Table 2d to this subpart that apply to you. These instances are deviations from the emission and operating limitations in this subpart. These deviations must be reported according to the requirements in §63.6650. If you change your catalyst, you must reestablish the values of the operating parameters measured during the initial performance test. When you reestablish the values of your operating parameters, you must also conduct a performance test to demonstrate that you are meeting the required emission limitation applicable to your stationary RICE.

(c) - (e) Not applicable.

(f) If you own or operate an emergency stationary RICE, you must operate the emergency stationary RICE according to the requirements in paragraphs (f)(1) through (4) of this section. In order for the engine to be considered an emergency stationary RICE under this subpart, any operation other than emergency operation, maintenance and testing, emergency demand response, and operation in non-emergency situations for 50 hours per year, as described in paragraphs (f)(1) through (4) of this section, is prohibited. If you do not operate the engine according to the requirements in paragraphs (f)(1) through (4) of this section, the engine will not be considered an emergency engine under this subpart and must meet all requirements for non-emergency engines.

(1) There is no time limit on the use of emergency stationary RICE in emergency situations.

(2) You may operate your emergency stationary RICE for any combination of the purposes specified in paragraphs (f)(2)(i) through (iii) of this section for a maximum of 100 hours per calendar year. Any operation for non-emergency situations as

**SECTION D. Source Level Requirements**

allowed by paragraphs (f)(3) and (4) of this section counts as part of the 100 hours per calendar year allowed by this paragraph (f)(2).

(i) Emergency stationary RICE may be operated for maintenance checks and readiness testing, provided that the tests are recommended by federal, state or local government, the manufacturer, the vendor, the regional transmission organization or equivalent balancing authority and transmission operator, or the insurance company associated with the engine. The owner or operator may petition the Administrator for approval of additional hours to be used for maintenance checks and readiness testing, but a petition is not required if the owner or operator maintains records indicating that federal, state, or local standards require maintenance and testing of emergency RICE beyond 100 hours per calendar year.

(ii) Emergency stationary RICE may be operated for emergency demand response for periods in which the Reliability Coordinator under the North American Electric Reliability Corporation (NERC) Reliability Standard EOP-002-3, Capacity and Energy Emergencies (incorporated by reference, see §63.14), or other authorized entity as determined by the Reliability Coordinator, has declared an Energy Emergency Alert Level 2 as defined in the NERC Reliability Standard EOP-002-3.

(iii) Emergency stationary RICE may be operated for periods where there is a deviation of voltage or frequency of 5 percent or greater below standard voltage or frequency.

(3) Emergency stationary RICE located at major sources of HAP may be operated for up to 50 hours per calendar year in non-emergency situations. The 50 hours of operation in non-emergency situations are counted as part of the 100 hours per calendar year for maintenance and testing and emergency demand response provided in paragraph (f)(2) of this section. The 50 hours per year for non-emergency situations cannot be used for peak shaving or non-emergency demand response, or to generate income for a facility to supply power to an electric grid or otherwise supply power as part of a financial arrangement with another entity.

(4) Not applicable.

VII. ADDITIONAL REQUIREMENTS.**# 010 [40 CFR Part 63 NESHAPS for Source Categories §40 CFR 63.6585]****Subpart ZZZZ - National Emissions Standards for Hazardous Air Pollutants for Stationary Reciprocating Internal Combustion Engines****Am I subject to this subpart?**

You are subject to this subpart if you own or operate a stationary RICE at a major or area source of HAP emissions, except if the stationary RICE is being tested at a stationary RICE test cell/stand.

(a) A stationary RICE is any internal combustion engine which uses reciprocating motion to convert heat energy into mechanical work and which is not mobile. Stationary RICE differ from mobile RICE in that a stationary RICE is not a non-road engine as defined at 40 CFR 1068.30, and is not used to propel a motor vehicle or a vehicle used solely for competition.

(b) A major source of HAP emissions is a plant site that emits or has the potential to emit any single HAP at a rate of 10 tons (9.07 megagrams) or more per year or any combination of HAP at a rate of 25 tons (22.68 megagrams) or more per year, except that for oil and gas production facilities, a major source of HAP emissions is determined for each surface site.

(c) An area source of HAP emissions is a source that is not a major source.

(d) - (f) Not applicable.

011 [40 CFR Part 63 NESHAPS for Source Categories §40 CFR 63.6590]**Subpart ZZZZ - National Emissions Standards for Hazardous Air Pollutants for Stationary Reciprocating Internal Combustion Engines****What parts of my plant does this subpart cover?**

This subpart applies to each affected source.

**SECTION D. Source Level Requirements**

(a) Affected source. An affected source is any existing, new, or reconstructed stationary RICE located at a major or area source of HAP emissions, excluding stationary RICE being tested at a stationary RICE test cell/stand.

(1) Existing stationary RICE.

(i) Not applicable.

(ii) For stationary RICE with a site rating of less than or equal to 500 brake HP located at a major source of HAP emissions, a stationary RICE is existing if you commenced construction or reconstruction of the stationary RICE before June 12, 2006.

(iii) - (iv) Not applicable.

(2) Not applicable.

(3) Not applicable.

(b) Not applicable.

(c) Not applicable.

012 [40 CFR Part 63 NESHAPS for Source Categories §40 CFR 63.6595]

Subpart ZZZZ - National Emissions Standards for Hazardous Air Pollutants for Stationary Reciprocating Internal Combustion Engines

When do I have to comply with this subpart?

(a) Affected sources. (1) If you have an existing stationary CI RICE with a site rating of less than or equal to 500 brake HP located at a major source of HAP emissions, you must comply with the applicable emission limitations, operating limitations, and other requirements no later than May 3, 2013.

***** Permit Shield in Effect. *****

**SECTION D. Source Level Requirements**

Model years(s) -> 2009+

NMHC + NOX -> 3.0 g/BHP-hr

PM -> 0.15 g/BHP-hr

Fuel Restriction(s).

006 [40 CFR Part 60 Standards of Performance for New Stationary Sources §40 CFR 60.4207]
Subpart III - Standards of Performance for Stationary Compression Ignition Internal Combustion Engines
What fuel requirements must I meet if I am an owner or operator of a stationary CI internal combustion engine subject to

(a) Beginning October 1, 2007, owners and operators of stationary CI ICE subject to this subpart that use diesel fuel must use diesel fuel that meets the requirements of 40 CFR 80.510(a).

(b) Beginning October 1, 2010, owners and operators of stationary CI ICE subject to this subpart with a displacement of less than 30 liters per cylinder that use diesel fuel must use diesel fuel that meets the requirements of 40 CFR 80.510(b) for nonroad diesel fuel, except that any existing diesel fuel purchased (or otherwise obtained) prior to October 1, 2010, may be used until depleted.

(c) - (e) Not applicable.

II. TESTING REQUIREMENTS.

No additional testing requirements exist except as provided in other sections of this permit including Section B (Title V General Requirements) and/or Section E (Source Group Restrictions).

III. MONITORING REQUIREMENTS.

007 [40 CFR Part 60 Standards of Performance for New Stationary Sources §40 CFR 60.4209]
Subpart III - Standards of Performance for Stationary Compression Ignition Internal Combustion Engines
What are the monitoring requirements if I am an owner or operator of a stationary CI internal combustion engine?

If you are an owner or operator, you must meet the monitoring requirements of this section. In addition, you must also meet the monitoring requirements specified in §60.4211.

(a) If you are an owner or operator of an emergency stationary CI internal combustion engine that does not meet the standards applicable to non-emergency engines, you must install a non-resettable hour meter prior to startup of the engine.

(b) If you are an owner or operator of a stationary CI internal combustion engine equipped with a diesel particulate filter to comply with the emission standards in §60.4204, the diesel particulate filter must be installed with a backpressure monitor that notifies the owner or operator when the high backpressure limit of the engine is approached.

IV. RECORDKEEPING REQUIREMENTS.

008 [40 CFR Part 60 Standards of Performance for New Stationary Sources §40 CFR 60.4214]
Subpart III - Standards of Performance for Stationary Compression Ignition Internal Combustion Engines
What are my notification, reporting, and recordkeeping requirements if I am an owner or operator of a stationary CI internal combustion engine?

(a) Not applicable.

(b) If the stationary CI internal combustion engine is an emergency stationary internal combustion engine, the owner or operator is not required to submit an initial notification. Starting with the model years in table 5 to this subpart, if the emergency engine does not meet the standards applicable to non-emergency engines in the applicable model year, the

**SECTION D. Source Level Requirements**

owner or operator must keep records of the operation of the engine in emergency and non-emergency service that are recorded through the non-resettable hour meter. The owner must record the time of operation of the engine and the reason the engine was in operation during that time.

(c) If the stationary CI internal combustion engine is equipped with a diesel particulate filter, the owner or operator must keep records of any corrective action taken after the backpressure monitor has notified the owner or operator that the high backpressure limit of the engine is approached.

(d) - (e) Not applicable.

V. REPORTING REQUIREMENTS.

No additional reporting requirements exist except as provided in other sections of this permit including Section B (Title V General Requirements) and/or Section E (Source Group Restrictions).

VI. WORK PRACTICE REQUIREMENTS.

009 [40 CFR Part 60 Standards of Performance for New Stationary Sources §40 CFR 60.4211]

Subpart III - Standards of Performance for Stationary Compression Ignition Internal Combustion Engines

What are my compliance requirements if I am an owner or operator of a stationary CI internal combustion engine?

(a) If you are an owner or operator and must comply with the emission standards specified in this subpart, you must do all of the following, except as permitted under paragraph (g) of this section:

(1) Operate and maintain the stationary CI internal combustion engine and control device according to the manufacturer's emission-related written instructions;

(2) Change only those emission-related settings that are permitted by the manufacturer; and

(3) Meet the requirements of 40 CFR parts 89, 94 and/or 1068, as they apply to you.

(b) - (e) Not applicable.

(f) If you own or operate an emergency stationary ICE, you must operate the emergency stationary ICE according to the requirements in paragraphs (f)(1) through (3) of this section. In order for the engine to be considered an emergency stationary ICE under this subpart, any operation other than emergency operation, maintenance and testing, emergency demand response, and operation in non-emergency situations for 50 hours per year, as described in paragraphs (f)(1) through (3) of this section, is prohibited. If you do not operate the engine according to the requirements in paragraphs (f)(1) through (3) of this section, the engine will not be considered an emergency engine under this subpart and must meet all requirements for non-emergency engines.

(1) There is no time limit on the use of emergency stationary ICE in emergency situations.

(2) You may operate your emergency stationary ICE for any combination of the purposes specified in paragraphs (f)(2)(i) through (iii) of this section for a maximum of 100 hours per calendar year. Any operation for non-emergency situations as allowed by paragraph (f)(3) of this section counts as part of the 100 hours per calendar year allowed by this paragraph (f)(2).

(i) Emergency stationary ICE may be operated for maintenance checks and readiness testing, provided that the tests are recommended by federal, state or local government, the manufacturer, the vendor, the regional transmission organization or equivalent balancing authority and transmission operator, or the insurance company associated with the engine. The owner or operator may petition the Administrator for approval of additional hours to be used for maintenance checks and readiness testing, but a petition is not required if the owner or operator maintains records indicating that federal, state, or local standards require maintenance and testing of emergency ICE beyond 100 hours per calendar year.

(ii) Emergency stationary ICE may be operated for emergency demand response for periods in which the Reliability

**SECTION D. Source Level Requirements**

Coordinator under the North American Electric Reliability Corporation (NERC) Reliability Standard EOP-002-3, Capacity and Energy Emergencies (incorporated by reference, see §60.17), or other authorized entity as determined by the Reliability Coordinator, has declared an Energy Emergency Alert Level 2 as defined in the NERC Reliability Standard EOP-002-3.

(iii) Emergency stationary ICE may be operated for periods where there is a deviation of voltage or frequency of 5 percent or greater below standard voltage or frequency.

(3) Emergency stationary ICE may be operated for up to 50 hours per calendar year in non-emergency situations. The 50 hours of operation in non-emergency situations are counted as part of the 100 hours per calendar year for maintenance and testing and emergency demand response provided in paragraph (f)(2) of this section. Except as provided in paragraph (f)(3)(i) of this section, the 50 hours per calendar year for non-emergency situations cannot be used for peak shaving or non-emergency demand response, or to generate income for a facility to an electric grid or otherwise supply power as part of a financial arrangement with another entity.

(i) The 50 hours per year for non-emergency situations can be used to supply power as part of a financial arrangement with another entity if all of the following conditions are met:

(A) The engine is dispatched by the local balancing authority or local transmission and distribution system operator;

(B) The dispatch is intended to mitigate local transmission and/or distribution limitations so as to avert potential voltage collapse or line overloads that could lead to the interruption of power supply in a local area or region.

(C) The dispatch follows reliability, emergency operation or similar protocols that follow specific NERC, regional, state, public utility commission or local standards or guidelines.

(D) The power is provided only to the facility itself or to support the local transmission and distribution system.

(E) The owner or operator identifies and records the entity that dispatches the engine and the specific NERC, regional, state, public utility commission or local standards or guidelines that are being followed for dispatching the engine. The local balancing authority or local transmission and distribution system operator may keep these records on behalf of the engine owner or operator.

(ii) [Reserved]

(g) If you do not install, configure, operate, and maintain your engine and control device according to the manufacturer's emission-related written instructions, or you change emission-related settings in a way that is not permitted by the manufacturer, you must demonstrate compliance as follows:

(1) Not applicable.

(2) If you are an owner or operator of a stationary CI internal combustion engine greater than or equal to 100 HP and less than or equal to 500 HP, you must keep a maintenance plan and records of conducted maintenance and must, to the extent practicable, maintain and operate the engine in a manner consistent with good air pollution control practice for minimizing emissions. In addition, you must conduct an initial performance test to demonstrate compliance with the applicable emission standards within 1 year of startup, or within 1 year after an engine and control device is no longer installed, configured, operated, and maintained in accordance with the manufacturer's emission-related written instructions, or within 1 year after you change emission-related settings in a way that is not permitted by the manufacturer.

(3) Not applicable.

(h) Not applicable.

VII. ADDITIONAL REQUIREMENTS.

**# 010 [40 CFR Part 60 Standards of Performance for New Stationary Sources §40 CFR 60.4200]
Subpart III - Standards of Performance for Stationary Compression Ignition Internal Combustion Engines
Am I subject to this subpart?**

**SECTION D. Source Level Requirements**

(a) The provisions of this subpart are applicable to manufacturers, owners, and operators of stationary compression ignition (CI) internal combustion engines (ICE) and other persons as specified in paragraphs (a)(1) through (4) of this section. For the purposes of this subpart, the date that construction commences is the date the engine is ordered by the owner or operator.

- (1) Not applicable.
- (2) Owners and operators of stationary CI ICE that commence construction after July 11, 2005, where the stationary CI ICE are:
 - (i) Not applicable.
 - (ii) Manufactured as a certified National Fire Protection Association (NFPA) fire pump engine after July 1, 2006.
- (3) - (4) Not applicable.

(b) - (e) Not applicable.

011 [40 CFR Part 63 NESHAPS for Source Categories §40 CFR 63.6585]

Subpart ZZZZ - National Emissions Standards for Hazardous Air Pollutants for Stationary Reciprocating Internal Combustion Engines

Am I subject to this subpart?

You are subject to this subpart if you own or operate a stationary RICE at a major or area source of HAP emissions, except if the stationary RICE is being tested at a stationary RICE test cell/stand.

- (a) A stationary RICE is any internal combustion engine which uses reciprocating motion to convert heat energy into mechanical work and which is not mobile. Stationary RICE differ from mobile RICE in that a stationary RICE is not a non-road engine as defined at 40 CFR 1068.30, and is not used to propel a motor vehicle or a vehicle used solely for competition.
- (b) A major source of HAP emissions is a plant site that emits or has the potential to emit any single HAP at a rate of 10 tons (9.07 megagrams) or more per year or any combination of HAP at a rate of 25 tons (22.68 megagrams) or more per year, except that for oil and gas production facilities, a major source of HAP emissions is determined for each surface site.
- (c) An area source of HAP emissions is a source that is not a major source.
- (d) - (f) Not applicable.

012 [40 CFR Part 63 NESHAPS for Source Categories §40 CFR 63.6590]

Subpart ZZZZ - National Emissions Standards for Hazardous Air Pollutants for Stationary Reciprocating Internal Combustion Engines

What parts of my plant does this subpart cover?

This subpart applies to each affected source.

- (a) Affected source. An affected source is any existing, new, or reconstructed stationary RICE located at a major or area source of HAP emissions, excluding stationary RICE being tested at a stationary RICE test cell/stand.
 - (1) Not applicable.
 - (2) New stationary RICE.
 - (i) Not applicable.
 - (ii) A stationary RICE with a site rating of equal to or less than 500 brake HP located at a major source of HAP emissions is new if you commenced construction of the stationary RICE on or after June 12, 2006.
 - (iii) Not applicable.
 - (3) Not applicable.
- (b) Not applicable.

**SECTION D. Source Level Requirements**

(c) Stationary RICE subject to Regulations under 40 CFR Part 60. An affected source that meets any of the criteria in paragraphs (c)(1) through (7) of this section must meet the requirements of this part by meeting the requirements of 40 CFR part 60 subpart IIII, for compression ignition engines or 40 CFR part 60 subpart JJJJ, for spark ignition engines. No further requirements apply for such engines under this part.

(1) - (5) Not applicable.

(6) A new or reconstructed emergency or limited use stationary RICE with a site rating of less than or equal to 500 brake HP located at a major source of HAP emissions;

(7) A new or reconstructed compression ignition (CI) stationary RICE with a site rating of less than or equal to 500 brake HP located at a major source of HAP emissions.

***** Permit Shield in Effect. *****

**SECTION E. Source Group Restrictions.**

Group Name: G01

Group Description: Presumptive RACT Sources

Sources included in this group

ID	Name
103	VAPORIZER
115	SULFUR RAILCAR UNLOADING
117	SULFUR STORAGE TANKS
123	PROCESS OIL TANK #1
124	PROCESS OIL TANK #2
201	EMERGENCY DIESEL GENERATOR (226 BHP)
203	EMERGENCY FIRE PUMP ENGINE #2 (238 BHP)
C02	THERMAL OXIDIZER
C04A	DONALDSON TORIT PACKAGING BAGHOUSE
C101	CRYSTEX PLANT EMERGENCY FLARE

I. RESTRICTIONS.

No additional requirements exist except as provided in other sections of this permit including Section B (Title V General Requirements).

II. TESTING REQUIREMENTS.

No additional testing requirements exist except as provided in other sections of this permit including Section B (Title V General Requirements).

III. MONITORING REQUIREMENTS.

No additional monitoring requirements exist except as provided in other sections of this permit including Section B (Title V General Requirements).

IV. RECORDKEEPING REQUIREMENTS.**# 001 [25 Pa. Code §129.100]****Compliance demonstration and recordkeeping requirements.**

a) - (c) Not applicable.

(d) The owner and operator of an air contamination source subject to this section and §§ 129.96—129.99 shall keep records to demonstrate compliance with §§ 129.96—129.99 in the following manner:

(1) The records must include sufficient data and calculations to demonstrate that the requirements of §§ 129.96—129.99 are met.

(2) Data or information required to determine compliance shall be recorded and maintained in a time frame consistent with the averaging period of the requirement.

(e) Not applicable.

(f) Not applicable.

(g) Not applicable.

(h) Not applicable.

(i) The records shall be retained by the owner or operator for 5 years and made available to the Department or appropriate approved local air pollution control agency upon receipt of a written request from the Department or appropriate approved local air pollution agency.

**SECTION E. Source Group Restrictions.****V. REPORTING REQUIREMENTS.**

No additional reporting requirements exist except as provided in other sections of this permit including Section B (Title V General Requirements).

VI. WORK PRACTICE REQUIREMENTS.**# 002 [25 Pa. Code §129.97]****Presumptive RACT requirements, RACT emission limitations and petition for alternative compliance schedule.**

(a) The owner and operator of a source listed in one or more of subsections (b)—(h) located at a major VOC emitting facility subject to §129.96 (relating to applicability) shall comply with the applicable presumptive RACT requirement or RACT emission limitation, or both, beginning with the specified compliance date as follows, unless an alternative compliance schedule is submitted and approved under subsections (k)—(m) or § 129.99 (relating to alternative RACT proposal and petition for alternative compliance schedule):

(1) January 1, 2017, for a source subject to § 129.96(a).

(2) January 1, 2017, or 1 year after the date the source meets the definition of a major NOx emitting facility or major VOC emitting facility, whichever is later, for a source subject to §129.96(b).

(b) Not applicable.

(c) The owner and operator of a source specified in this subsection, which is located at a major VOC emitting facility subject to § 129.96 shall install, maintain and operate the source in accordance with the manufacturer's specifications and with good operating practices:

(1) Not applicable.

(2) A VOC air contamination source that has the potential to emit less than 2.7 TPY of VOC.

[Sources 103, 115, 117, 122, and Control Device C04]

(3) Not applicable.

(4) Not applicable.

(5) A stationary internal combustion engine rated at less than 500 bhp (gross).

[Sources 201 and 203]

(6) An incinerator, thermal oxidizer, or catalytic oxidizer used primarily for air pollution control.

[Control Devices C02 and C101]

(7) Not applicable.

(8) Not applicable.

(d) Except as specified under subsection (c), the owner and operator of a combustion unit or other combustion source located at a major VOC emitting facility subject to § 129.96 shall install, maintain and operate the source in accordance with the manufacturer's specifications and with good operating practices for the control of the VOC emissions from the combustion unit or other combustion source.

(e) - (m) Not applicable.

VII. ADDITIONAL REQUIREMENTS.

No additional requirements exist except as provided in other sections of this permit including Section B (Title V General Requirements).

***** Permit Shield in Effect. *****

**SECTION E. Source Group Restrictions.**

Group Name: G02

Group Description: Capacity and throughput value statement

Sources included in this group

ID	Name
034	BOILER #1
035	BOILER #2
101	CRYSTEX PLANT
103	VAPORIZER
115	SULFUR RAILCAR UNLOADING
117	SULFUR STORAGE TANKS
123	PROCESS OIL TANK #1
124	PROCESS OIL TANK #2
125	TANK TRUCK UNLOADING OF SULFUR
201	EMERGENCY DIESEL GENERATOR (226 BHP)
202	EMERGENCY FIRE PUMP ENGINE #1 (152 BHP)
203	EMERGENCY FIRE PUMP ENGINE #2 (238 BHP)

I. RESTRICTIONS.

No additional requirements exist except as provided in other sections of this permit including Section B (Title V General Requirements).

II. TESTING REQUIREMENTS.

No additional testing requirements exist except as provided in other sections of this permit including Section B (Title V General Requirements).

III. MONITORING REQUIREMENTS.

No additional monitoring requirements exist except as provided in other sections of this permit including Section B (Title V General Requirements).

IV. RECORDKEEPING REQUIREMENTS.

No additional record keeping requirements exist except as provided in other sections of this permit including Section B (Title V General Requirements).

V. REPORTING REQUIREMENTS.

No additional reporting requirements exist except as provided in other sections of this permit including Section B (Title V General Requirements).

VI. WORK PRACTICE REQUIREMENTS.

No additional work practice requirements exist except as provided in other sections of this permit including Section B (Title V General Requirements).

VII. ADDITIONAL REQUIREMENTS.**# 001 [25 Pa. Code §127.441]****Operating permit terms and conditions.**

Capacity and throughput values are provided for informational purposes and are not enforceable conditions or limitations.

***** Permit Shield in Effect. *****

**SECTION F. Alternative Operation Requirements.**

Alternative Operation Name: BYPASS OF THERMAL OXIDIZER

#001 CHANGES FROM NORMAL OPERATION

Alternative emission limitation and process throughput reduction.

Sources included in this Alternative Operation:

ID	Name	Source Type
101	CRYSTEX PLANT	Process

I. RESTRICTIONS.**Emission Restriction(s).****# 001 [25 Pa. Code §127.511]****Monitoring and related recordkeeping and reporting requirements.**

During periods when the thermal oxidizer is bypassed due to maintenance requirements, mechanical or fuel upset conditions, Flexsys shall take all feasible steps to promptly return the thermal oxidizer to service. Should a bypass occur for more than 14.5 hours in any 24 hour period, the permittee shall institute effective measures (such as curtailing production) such that VOC emissions shall not exceed 1.0 tons per year on a 12-month rolling sum from the CS2 Recovery Absorber Stack (Bypass), (Stack S06).

002 [25 Pa. Code §127.511]**Monitoring and related recordkeeping and reporting requirements.**

During periods when the thermal oxidizer is bypassed due to maintenance requirements, mechanical or fuel upset conditions, combined hydrogen sulfide emissions from the CS2 recovery system vent stack and thermal oxidizer shall not exceed 0.279 lb/hr averaged over the 24-hour period beginning with the start of the bypass. Flexsys shall take all feasible steps to promptly return the thermal oxidizer to service. Should a bypass occur for more than 14.5 hours in any 24 hour period, the permittee shall institute effective measures (such as curtailing production) to ensure compliance with this limit, and demonstrate compliance with this limit in accordance with Condition #003.

II. TESTING REQUIREMENTS.

No additional testing requirements exist except as provided in other sections of this permit including Section B (Title V General Requirements) and/or Section E (Source Group Restrictions).

III. MONITORING REQUIREMENTS.**# 003 [25 Pa. Code §127.511]****Monitoring and related recordkeeping and reporting requirements.**

For bypasses occurring more than 14.5 hour in any 24-hour period, the permittee shall;

(a) demonstrate compliance with the 0.279 lb/hr hydrogen sulfide (H₂S) limit averaged over the 24-hour period beginning with the start of the bypass.

(b) monitor H₂S emissions with a device accepted by the Department for use under this condition that records actual emission concentrations, or use another method with prior written Department approval.

IV. RECORDKEEPING REQUIREMENTS.**# 004 [25 Pa. Code §127.511]****Monitoring and related recordkeeping and reporting requirements.**

The permittee shall record all bypasses of the thermal oxidizer and the Crystex Plant maximum production rate.

**SECTION F. Alternative Operation Requirements.****V. REPORTING REQUIREMENTS.****# 005 [25 Pa. Code §127.12b]****Plan approval terms and conditions.**

In accordance with Plan Approval 63-313-029, Condition No.15, the permittee shall notify the Department of all bypasses of the thermal oxidizer.

VI. WORK PRACTICE REQUIREMENTS.

No additional work practice requirements exist except as provided in other sections of this permit including Section B (Title V General Requirements) and/or Section E (Source Group Restrictions).

VII. ADDITIONAL REQUIREMENTS.

No additional requirements exist except as provided in other sections of this permit including Section B (Title V General Requirements) and/or Section E (Source Group Restrictions).

***** Permit Shield in Effect. *****



SECTION G. Emission Restriction Summary.

Source Id	Source Description
-----------	--------------------

Site Emission Restriction Summary

Emission Limit		Pollutant
102.800 Tons/Yr	Rolled Monthly	VOC

Alternative Operation Emission Restriction Summary

Source Id	Source Description
-----------	--------------------

**SECTION H. Miscellaneous.**

1. The Sulfur Railcar Unloading operation (Source 115) includes the following emission units:

- Venting
- Unloading
- Depressurization

2. The Crystex Plant includes several individual emissions units as listed in the Title V permit application and have been identified as proprietary under 25 Pa. Code 127.411(d) and the permittee requests that the individual processes remain confidential.

3. These sources qualify as insignificant activities and have no applicable requirements, emission limits, monitoring, and/or recordkeeping.

- * Diesel Storage Tanks
- * Hot Water Heater #1, #2
- * Warehouse Fugitives
- * Boiler Water Treatment
- * Lab and Maintenance
- * Firewater Pumps (Fire pump engines are included in the permit as Source 203)
- * Packaging Maintenance activities and associated baghouse [formerly included in the TVOP as Control Device C03 - PACKAGING (MAINTENANCE)]
- * Sandblast operation controlled by 900 cfm dust collector (RFD - 03/29/2017 as de minimis emissions increase)
- * Welding Fume Extractor controlled by fume removal hood and filter (RFD - 03/29/2017 as de minimis emissions increase)
- * Paint Booth (RFD - 03/29/2017 as de minimis emissions increase)
- * 8,000-gallon CS₂ pressure vessel
- * 30,000-gallon CS₂ deinventory pressure vessel
- * Process mix tank
- * Process storage tank

4. In September 2019, the Department of Environmental Protection determined that the temporary venting of convey gas to atmosphere during a maintenance shutdown at the Flexsys America L.P. Monongahela Plant is exempt from Plan Approval requirements as a de minimis emission increase under Title 25 PA Code §127.449. It is the Department's understanding that VOC emissions from this project will not exceed 0.007 tpy, that this activity will cease once the facility is returned to production following the maintenance shutdown, that this project involves the packaging of approximately 180,000 KG (198.4 tons) of bagged Crystex product through the packaging system into bags, that the anticipated duration of this project will be less than 48 hours, that no production increase will occur as a result of this project, and that this project will not trigger the requirements of 25 PA Code Subchapter E (NANSR) or 40 CFR Part 52 (PSD).



***** End of Report *****
